



**Henderson**<sup>®</sup>  
Protecting Playground Fun<sup>™</sup>





**ACM Playgrounds, Inc.**  
PO Box 179, Buchanan, NY 10511  
T. 914-739-6858 F. 914-736-0554  
[www.acmplaygrounds.com](http://www.acmplaygrounds.com)





# Family Values

Our father, Gordon Henderson (1941-2016), started our family owned and operated business over 45 years ago. He always said we were in the business of "putting children first".

He believed that playgrounds should be fun and exciting, but also challenging and nurturing. The best playgrounds combine these values, and ensure that children are not just fit and happy, but also helps prepare them to reach their full potential in life.

Our Dad dedicated his life's work to creating fun environments for children. He was thrilled to play a part in connecting families within their communities and helping them thrive and grow.

This catalog is our continuing commitment to our father's legacy by providing you with innovative play events for all age groups and abilities; we have options to meet your needs and realize your vision.

Our focus is children, and we are thankful for yet another wonderful year committed to Putting Children First™.

Thank you Dad for your vision, your guidance, and your love. Your commitment to family drives us forward. We will miss you.



Andrew Henderson    Matthew Henderson  
Charles Henderson

The Henderson Family  
Andrew, Matthew, and Charles



# Table of Contents

Henderson has been a leader in quality-built playgrounds for over 45 years. We have the play equipment to meet the most demanding of customers – children that play on it. Choose from four playground lines and a plethora of components. Accentuate your playground with freestanding equipment, motion toys, swings or dinosaur digs and concrete play events.



## 4 - New Products

Henderson Recreation has lots of new products this catalog. New climbing events, new roofs, new panels, new overhead components and a new and improved Playtots product line. Check it out.



## 8 - Dinosaurs Digs and More

Discover amazingly real dinosaur digs cast from original dinosaur bones. Exciting and educational. We also offer a variety of concrete climbers and other play features that is sure to impress every child.



## 14 - PlaySteel FIT

PlaySteel fit is our most popular playground line. It's specifically designed to fit your space, fit your budget and fit your needs. We have many of designs to choose from or work with a representative to design your own.



## 40 - PlaySteel MAX

Maximize versatility, accessibility and component selection with PlaySteel Max, Henderson's premium play system. Max is large and in charge, and has our largest decks, our most durable posts, and our largest selection of play components.



## 68 - Mighty Shade

Mighty Shade is designed to work with our PlaySteel MAX and PlaySteel FIT product lines. Shade is essential in hot areas with unrelenting sun. Help protect children from heat and harmful UV rays while still enjoying outdoor play under a Mighty Shade playground.



## 72 - PlaySteel MAX and FIT Components

Interested in designing your own playground? Looking to alter our designs with play components of your choice? Well this is the place to start.



## 118 - Orbis

Orbis is our modern playground line with a focus on fitness. Kids love the Orbis often choosing it over traditional playgrounds to play on. You can't go wrong—each one is a proven winner with children.





### 136 - Orbis Components

Choose from a large variety of play components specifically designed for our Orbis playground line.



### 144 - PlayTots

Check out our new and improved popular PlayTots playground line. It's more colorful, more fun, and better in many ways.



### 148 - Motion Toys

Kids love motion! We love making them. Choose from our most popular selection of motion toys designed for one or multiple users.



### 156 - Freestanding Equipment

Looking for the perfect way to complete your playground? Henderson offers loads of innovative freestanding play events and stand-alone play items.



### 166 - Swings

Looking for the most iconic play event ever? Well you found them, swings are fundamental to any play environment. Henderson has lots of styles and sizes to choose from.



### 170 - Introducing Vista Furnishings

Henderson Recreation, working together with experts in the site furnishing industry, has designed, developed and manufactured a new line of site furnishings called Vista Furnishings.



### 174 - Color Combinations

Choosing a playground color combination may seem easy but many of our valued customers are often overwhelmed with so many color choices. We have provided you with 15 popular and pleasing color choices to choose from.



### 176 - Warranty & Terms

You can find all the technical warranty, terms, and industry affiliations here.



### 177 - Color Options

Need more color options than the color combinations we provide? Well this is the place to start to see all the available color choices we have to offer.



NEW

# New Products

Henderson has lots of new products to offer! From a complete redesign of our popular PlayTots Line to new and exciting components for our PlaySteel MAX and PlaySteel FIT playground lines.





### Alien Adventure Climber

A unique climber that kids can climb over, under or even sideways on this challenging new component. Includes alien themed climbing panel inserts.



### Transporter Super Cluster

We've turned the popular Transporter climber into a jungle. Multiple ways up and down and all round will make this new climber a ton of fun for kids.



### Inclined Board

A fun and creative climbing and balancing board children can use to challenge their abilities.

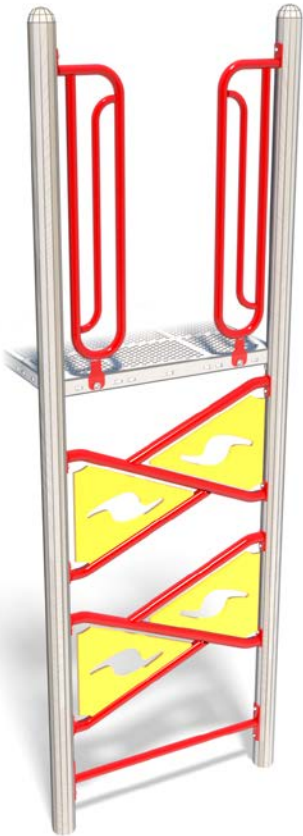

### Rudder Climber

HDPE plastic cut outs on a vertical steel climbing frame provide a rewarding but challenging climb to the top.

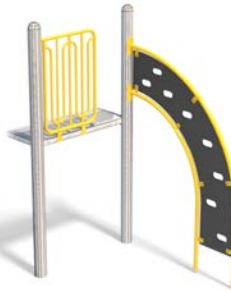

### Crescent Moon Climber

A vertical climbing arch that challenges the best climbers. A great addition to any playground. Made from HDPE non-skid plastic that adds extra traction for climbing and gripping.

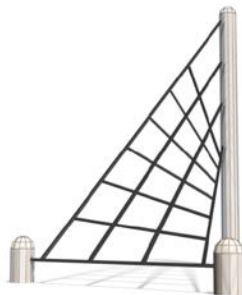

### Odyssey Space Net Link

This twisting net allows a child to transverse from the ground to the top of the net or to a deck in a more challenging way.



### Nature Adventure Climber

A unique climber that kids can climb over, under or even sideways on this challenging new climbing component. Includes nature themed climbing panel inserts.





# New Products

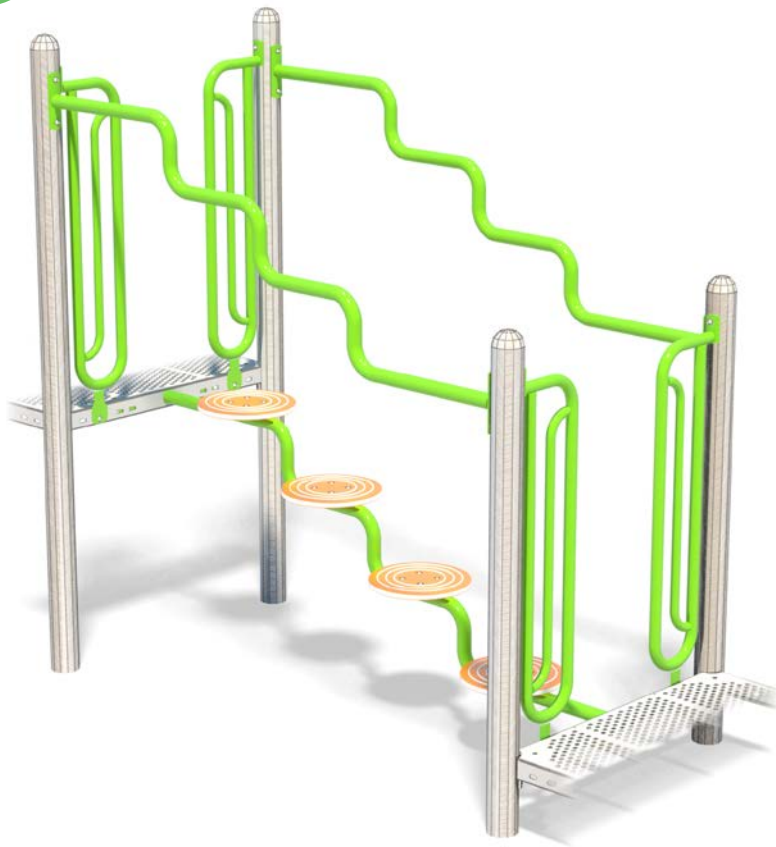

### Curly Link

Four HDPE disks with rings for traction provide a fun way to elevate children up two feet to the next level deck.

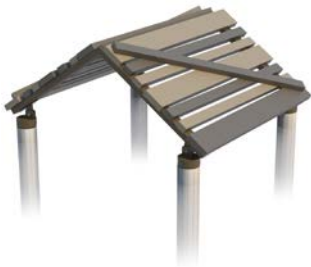

### Playfort Roof

Our new Playfort roof is really popular with kids. It may look like a bunch of kids built it but this one is really durable and is meant to last with a steel frame and recycled plastic boards.



### Playfort Magnifying Panel

Using the hand hole you can reach through to see objects in the center magnifying glass. What a great opportunity to teach children to look closely at ordinary or extraordinary things.



### Cargo Net

A two sided climbing net that can be accessed from the deck or the ground. Children can climb the net or traverse across it between the decks.

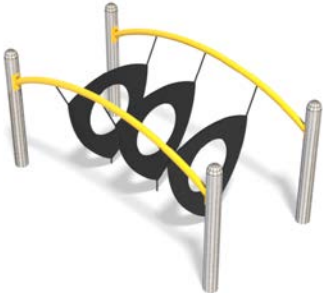

### Triangle Link

Children can challenge themselves to climb through or over the hanging triangle components.

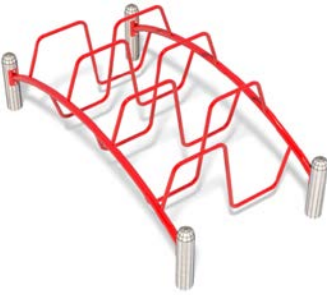

### "S" Link

An alternating climbing event that is most often used low to the ground.



### HALO ROOF

The Halo roof adds a new modern design look to any playground.

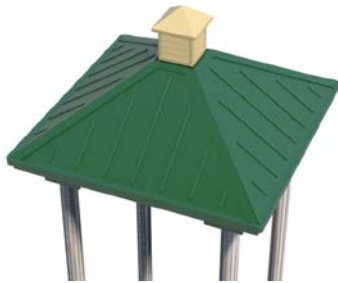

### Cupola Roof

A peaked roof design with a cupola on top.

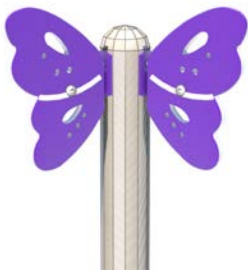

### Butterfly Post Topper

Top your post with our colorful and unique butterfly post topper.



### Hourglass Climber

A challenging vertical climbing event with moving components. A great way for children to develop their climbing skills in a fun way.



### Pine Tree Post Topper

Add a few pine tree post toppers to your nature inspired playground to enhance the natural look.



### Wishbone Overhead

A cost effective yet challenging overhead that tapers to one post. Children need to plan ahead to master this overhead activity.





# Dino Digs & More

NEW



## Allosaurus Dig

Another famous meat-eater the Allosaurus meaning "different lizard" roamed the earth 155-145 million years ago. Some paleontologists believe that they may have attacked in packs like wolves of today.  
 Dimensions - 31'-4" long (9.6m), 8'-3" wide (2.5m)



## Ankylosaur Dig

The Ankylosaur was an armoured tank kind of dinosaur that lived 68-66 million years ago. To date, a complete skeleton has not been found but kids can dig up some of the bones that have been discovered.  
 Dimensions - 5'-8" long (1.7m), 4'-4" wide (1.3m)





### Protoceratops Dig

The Protoceratops was a plant-eater that roamed earth 83 to 70 million years ago. Children can dig up this Protoceratops molded of actual fossils.  
Dimensions - 6' long (1.8m), 3'-11" wide (1.2m)

---



### Saurornitholestes Dig

The Saurornitholestes was fast and agile meat-eater that lived 80 to 70 million years ago. Saurornitholestes means "lizard-bird thief" because its skull had physical similarities to modern birds.  
Dimensions - 3'-6" long (1.1m), 2' wide (0.61m)

---



### Pachycephalosaur Dig

The Pachycephalosaur means "thick-headed lizard." It roamed earth in the late Cretaceous Period 70-66 million years ago.  
Dimensions - 3'-11" long (1.2m), 2'-11" wide (0.9m)

---



### Struthiomimus Dig

Children can pretend to be a paleontologist. Who knows these digs may spark a life long interest in fossils. The Struthiomimus lived 65 million years ago. It had no teeth and lived off insects, plants, fruit, and small lizards.  
Dimensions - 3' long (0.9m), 2'-2" wide (0.7m)

---

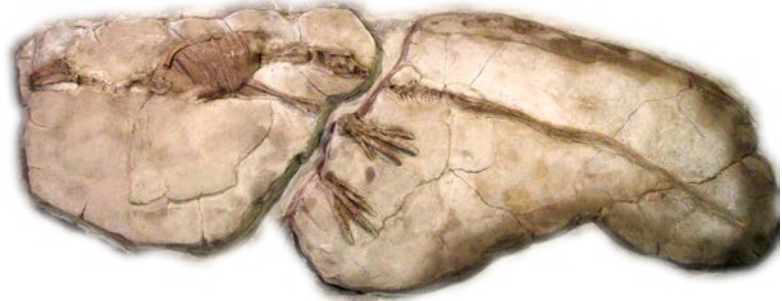

### Parksosaurus Dig

The Parksosaurus was a plant-eater that lived 65-68 million years ago in the late Cretaceous period.  
Dimensions - 9'-4" long (2.8m), 3'-5" wide (1.0m)

---



### Troodon Eggs

Molded off of original museum pieces this small cache of eggs is how the Troodon laid its young 65-75 million years ago.  
Dimensions - 4' long (1.2m), 3' wide (0.9m)

---



### Stegosaurus Dig

A scientifically accurate cast of a Stegosaurus. This life size dig will amaze kids as they slowly uncover the bones. Bury it again and delight other children in unearthing this huge Stegosaurus. Dated 150-145 million years ago.  
Dimensions - 29'-6" long (9.0m), 9'-6" wide (2.9m)

---



NEW

# The Mighty T-Rex



## T-Rex Dig Site

T-rex (meaning "Tyrant lizard king") was one of the world's largest meat eating dinosaurs at 40 feet long, 15 feet high and weighing 5 to 7 tons. T-rex roamed the earth 68 to 65 million years ago and was known for its large, powerful jaws and fearsome look. Interestingly, for such a large animal, the hands and

arms, though powerful, were quite small. This T-rex dig was cast off the second most complete T-rex specimen in the world. This is the T-rex on display at the Chicago museum. Bury this skeleton under sand and watch children be amazed as they uncover this huge life size T-rex.

Dimensions - 36' long (11.0m) x 14' (4.3m).

1. Caudal Vertebrae
2. Dorsal Vertebrae
3. Cervical Vertebrae
4. Ilium
5. Ischium
6. Pubis
7. Femur
8. Tibia
9. Fibula
10. Metatarsal
11. Phalange
12. Ribs
13. Scapula
14. Humerus
15. Radius
16. Ulna
17. Metacarpal
18. Skull
19. Orbit
20. Naris
21. Mandible
22. Teeth

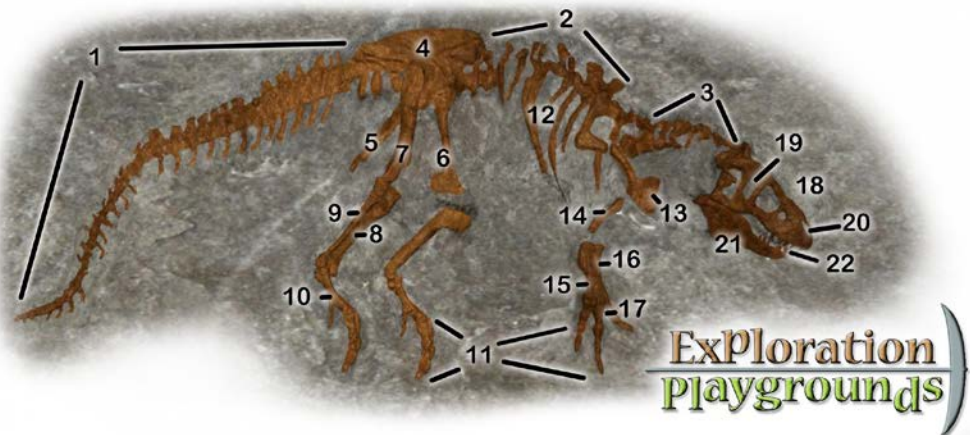





### Triceratops Head Climber

How cool is this? We are as amazed as you are. We wish the Triceratops Head Climber was available when we were kids.

Dimensions - 8' long (2.4m), 5' wide (1.5m)  
5'-7" tall (1.7m)



### Mastodon Dig (Only Head & Tusk Shown)

The mastodon is huge, divided into three sections children can dig up various parts of its bone accurate skeleton. Exciting, fun, and educational.

Dimensions - 23'-5" long (7.1m), 6'-5" wide (1.96m)  
12" tall (0.3m)



### Coelophysis Dig

The Coelophysis Dig is a smaller dinosaur dig easily suitable for any sand pit or even sand box near a playground or on its own.

Dimensions - 78" long (2.0m), 36" wide (0.9m)  
3" tall (76.2mm)





### T-Rex Climber

Want to climb on the head of the most famous dinosaur in the world? If you don't your children will want to for sure! This T-rex skull was created using casts from moulds taken from the original fossil of the Museum of the Rockies in Bozeman Montana. The Specimen is known as MOZ R 555

(Wankel). This specimen is the second most complete T-rex specimen discovered to date.

A fascinating climber to explore and learn about. Museum quality and accuracy that you can actually touch and play on. Enjoy!

Dimensions - 6' long (1.8m), 3'-10" wide (1.2m)  
5' tall (1.5m)



### Rib Climber

One of the most popular climbers from Exploration Playgrounds. This is a climbable museum piece in a public place. Children will be amazed!

Dimensions - 9'-11" long (2.0m), 4'-8" wide (0.4m)  
3'-10" tall (0.7m)



### Hollow Log Climber

What's better than climbing on a log? Climbing through one! The hollow log provides a 360° climbing experience. A must for any nature inspired playground environment.

Dimensions - 60" long (1.5m), 42" diameter (1.1m)





### Log Beam

Cross the fallen log to explore areas with dinosaur digs. A fun climber with many creative possibilities.  
Dimensions - 6'-4" long (1.9m), 3'-4" wide (1.0m)  
2'-5" tall (0.74m)

---



### Rattle Snake Point

Rattlesnakes like hiding out in rock crevices. Good thing there are none in this fun, nature inspired rock climber so children can safely explore it.  
Dimensions - 7'-11" long (2.4m), 4'-2" wide (1.3m)  
4'-2" tall (1.3m)

---



### Utah Climber

The Utah Climber was cast from a real rock in Utah. It provides an unprecedented real rock like climbing experience children will enjoy.  
Dimensions - 0'-0" long (0.0m), 0'-0" wide (0m)  
0'-0" tall (0.0m)

---



### Tree Rock

What's better than a rock or tree climber? A Tree Rock climber that combines the best of both features of nature inspired play.  
Dimensions - 6'-8" long (2.0m), 6'-3" wide (1.9m)  
7'-1" tall (2.2m)

---



### Castle Rock

This great Castle Rock climber can be used as a freestanding play event or it can be used to access 48" deck heights on PlaySteel MAX or FIT.  
Dimensions - 9'-2" long (2.8m), 6'-3" wide (1.9m)  
8'-5" tall (2.6m)

---



### Stump Transfer

The Stump Transfer can be used as a climber, bench or ADA transfer point to a point on PlaySteel MAX or PlaySteel Fit.  
Dimensions - 4'-5" long (1.3m), 4" wide (1.2m)  
23" tall (0.6m)

---



### Log Steppers

Log Steppers are an essential natural play element that children love to traverse. Use them as an access climber to playgrounds or freestanding.  
Dimensions - 12", 24", 36" (0.3, 0.61, 0.91m) heights.

---



### Log Bench

After a hard day playing on the playground or just running around, kids and adults too will enjoy relaxing on this new Log Bench.  
Dimensions - 6'-6" long (2.0m), 1'-4" wide (0.4m)  
2'-4" tall (0.7m)

---



### Balance Log

Balancing on a border or cement curb was so much fun as a kid. But now kids can balance on a realistic Balance Log, way cooler than a plain old curb.  
Dimensions - 12'-6" long (3.8m), 1'-11" wide (0.6m)  
2'-5" tall (0.7m)

---



# PlaySteel FIT





Fits your space  
Fits your budget  
Fits your needs







# The Perfect Fit

Looking for a playground that's a perfect fit for a tight space and tight budget? Look no further than PlaySteel Fit. Your dollar will go further with smart, cost-saving designs that don't sacrifice any play value. PlaySteel Fit features almost all of the same great components as our larger products with smaller decks and posts to keep costs lower. PlaySteel Fit is everything you need in a playground at a price you desire.

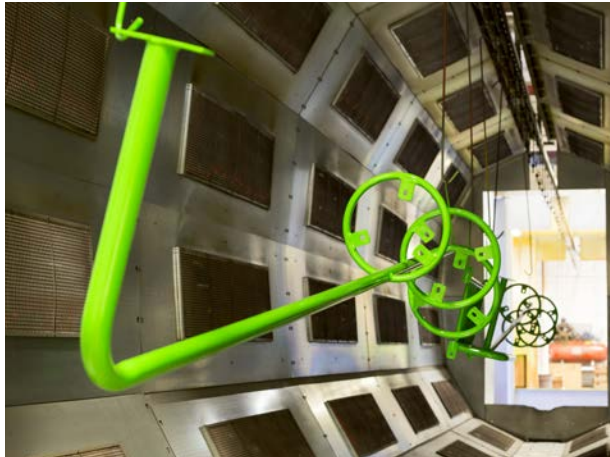

## Quality Built In

Henderson is an ISO 9001 registered and a CWB certified welding facility. Quality control is built into every product we manufacture. As a lean manufacturer we don't start making your product until it's ordered. We don't stock product which saves in waste and that translates into better prices for you.

## Designed by Experts

Our sales staff and representatives are trained to help you find the best play environment to suit your needs. Need a playground to fit a particular site? Want to customize your playground? Want to add your logo to a panel? Just talk to our representatives to get the ball rolling.

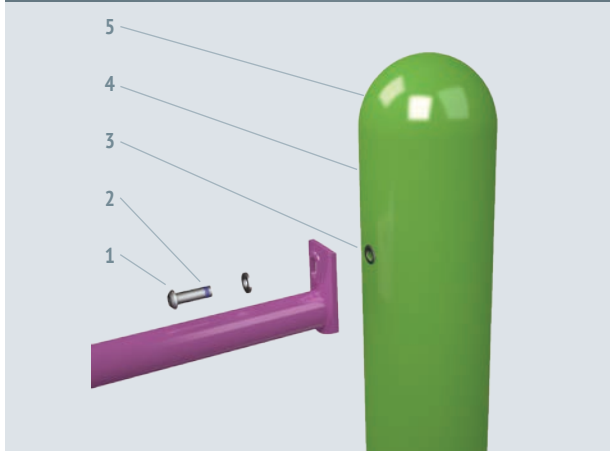

## Bolt-N-Go Technology

1. 304 alloy stainless steel tamper-resistant TORX® head bolts provide superior vandal resistance
2. Microspheres® thread-coating keeps bolts tight
3. Bolt-N-Go uprights arrive pre-threaded and ready to receive components
4. PlaySteel FIT uprights are 3.5" O.D. x 13 gauge galvanized steel for superior strength and durability
5. Durable cast-aluminum post caps





## Model #B302231R1

Age:	5 to 12	ASTM F1487:	✓
Play Events:	37	CAN/CSA-Z614:	✓
Use Zone:	47' x 45' (14.3 x 13.7m)	CPSC Pub.325:	✓
ADA:	✓		



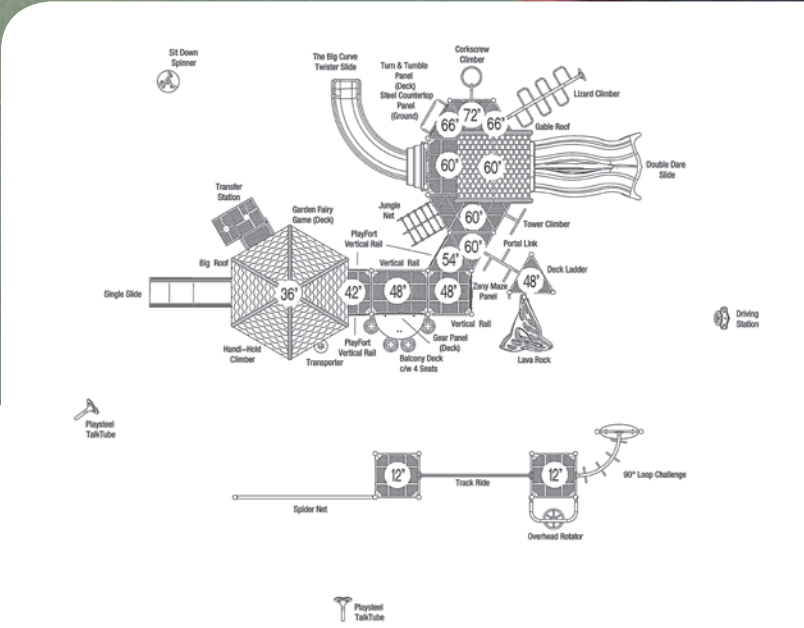



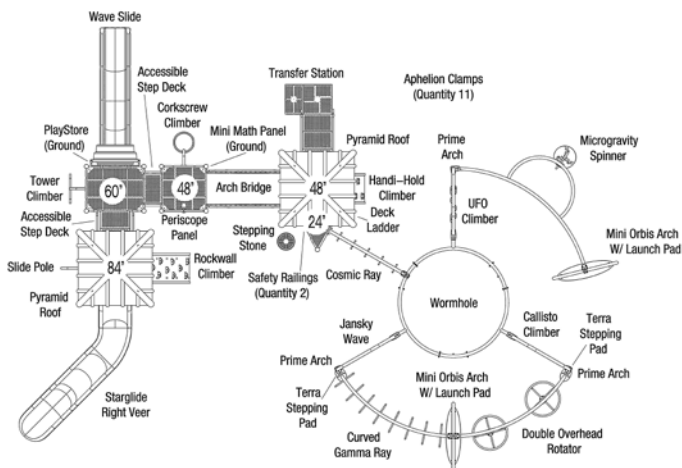





## Model #B301672

Age:	5 to 12	ASTM F1487:	✓
Play Events:	37	CAN/CSA-Z614:	✓
Use Zone:	54' x 42' (16.5 x 12.8m)	CPSC Pub.325:	✓
ADA:	✓		





## Model #B302801

Age:	5 to 12	ASTM F1487:	✓
Play Events:	37	CAN/CSA-Z614:	✓
Use Zone:	80' x 41' (24.4 x 12.5m)	CPSC Pub.325:	✓
ADA:	✓		



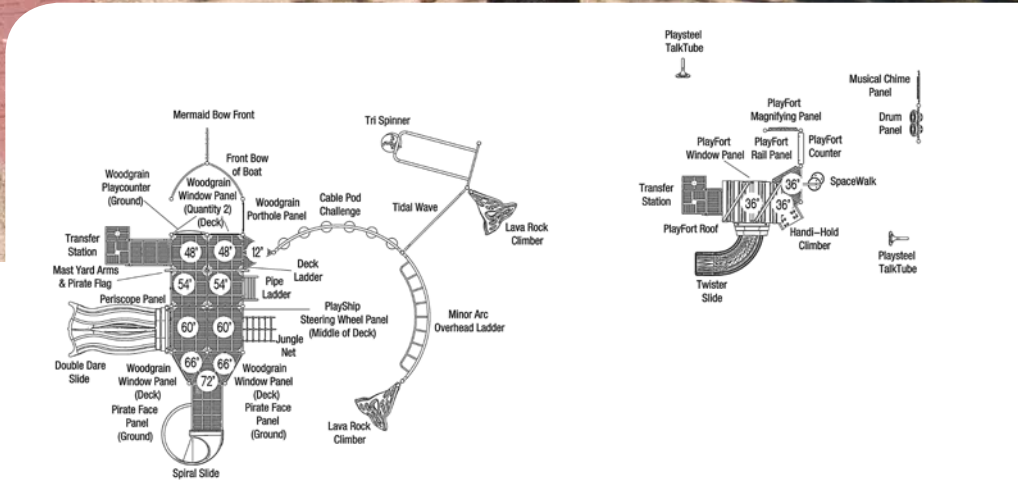





## Model #B302241R1

Age:	5 to 12	ASTM F1487:	✓
Play Events:	29	CAN/CSA-Z614:	✓
Use Zone:	73' x 46' (22.3 x 14.0m)	CPSC Pub.325:	✓
ADA:	✓		



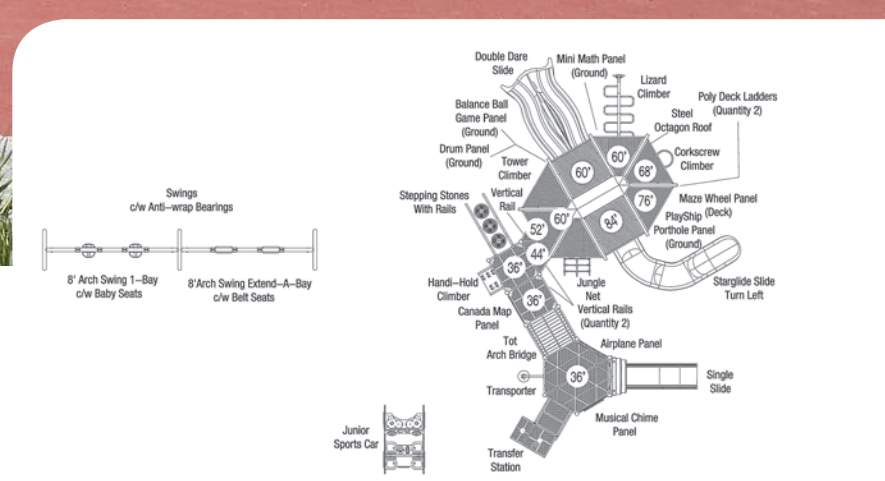



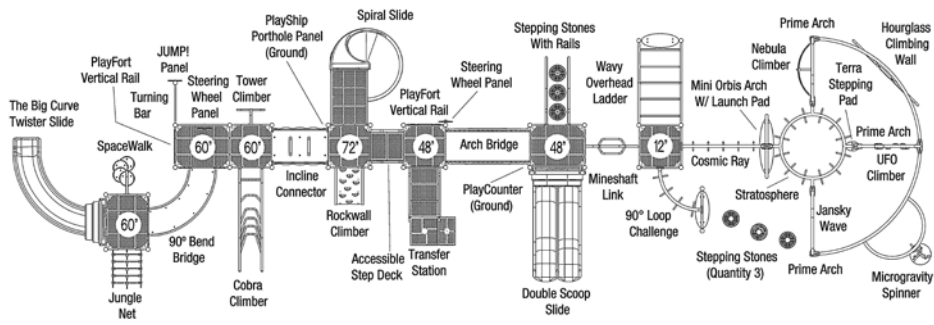





### Model #B302497R1

Age:	5 to 12	ASTM F1487:	✓
Play Events:	34	CAN/CSA-Z614:	✓
Use Zone:	79' x 34' (24.1 x 10.4m)	CPSC Pub.325:	✓
ADA:	✓		



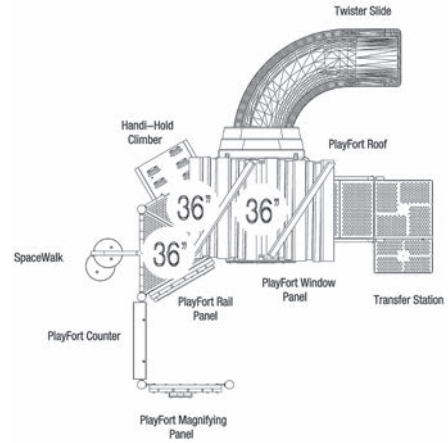

### Model #B303132

Age:	2 to 5 (1.5 to 5 CAN)	ASTM F1487:	✓
Play Events:	8	CAN/CSA-Z614:	✓
Use Zone:	25' x 25' (7.6 x 7.6m)	CPSC Pub.325:	✓
ADA:	✓		

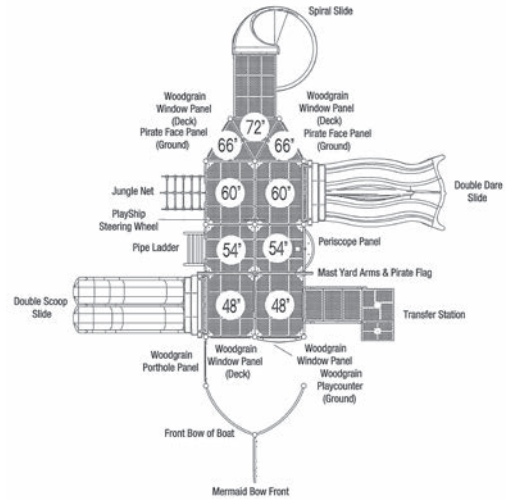

### Model #

Age:	5 to 12	ASTM F1487:	✓
Play Events:	20	CAN/CSA-Z614:	✓
Use Zone:	42' x 36' (12.8 x 11.0m)	CPSC Pub.325:	✓
ADA:	✓		





**Model #B302964**

Age: 5 to 12  
 Play Events: 12  
 Use Zone: 33' x 26' (10.0 x 7.9m)

ASTM F1487: ✓  
 CAN/CSA-Z614: ✓  
 CPSC Pub.325: ✓

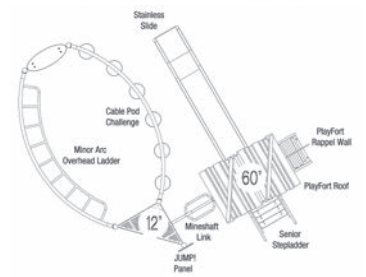





## Model #B302801 Jr. Unit

Age: 2 to 5 (1.5 to 5 CAN)  
 Play Events: 8  
 Use Zone: 25' x 25' (7.6 x 7.6m)  
 ADA: ✓

ASTM F1487: ✓  
 CAN/CSA-Z614: ✓  
 CPSC Pub.325: ✓

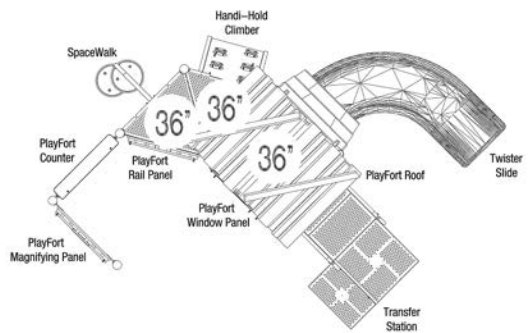



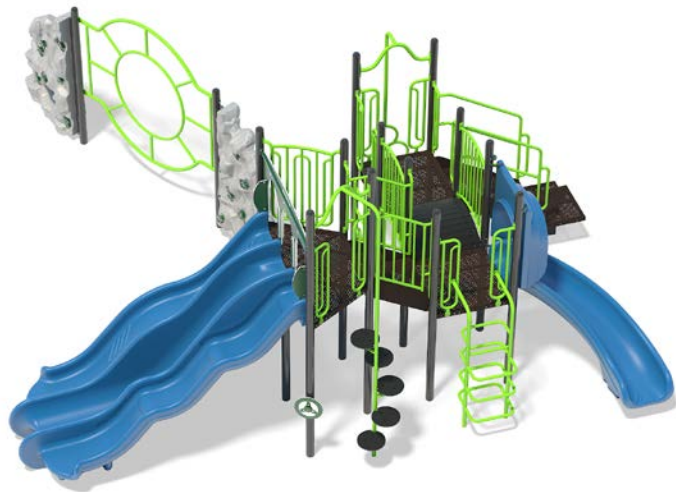
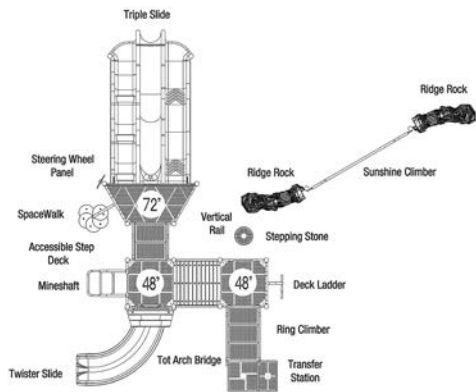

### Model #B303131

Age: 5 to 12  
 Play Events: 14  
 Use Zone: 39' x 36' (11.9 x 11.0m)  
 ADA: ✓

ASTM F1487: ✓  
 CAN/CSA-Z614: ✓  
 CPSC Pub.325: ✓

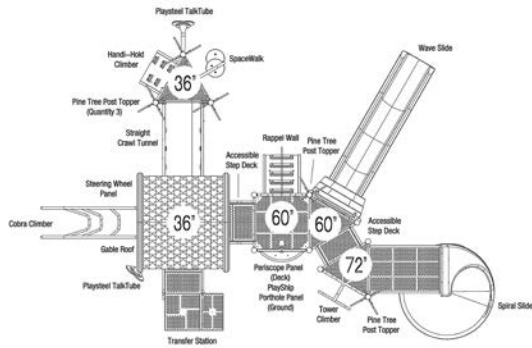

### Model #B303136

Age: 5 to 12  
 Play Events: 18  
 Use Zone: 37' x 30' (11.3 x 9.1m)  
 ADA: ✓

ASTM F1487: ✓  
 CAN/CSA-Z614: ✓  
 CPSC Pub.325: ✓



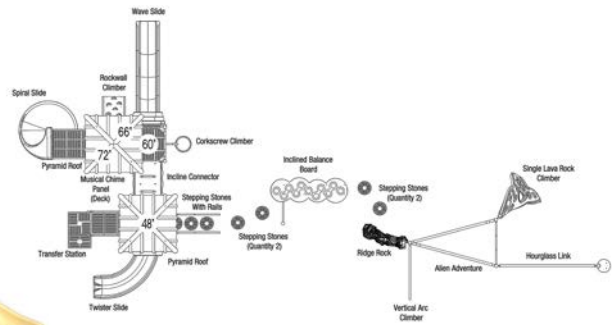

### Model #B303139

Age:	5 to 12	ASTM F1487:	✓
Play Events:	21	CAN/CSA-Z614:	✓
Use Zone:	65' x 37' (19.8 x 11.3m)	CPSC Pub.325:	✓
ADA:	✓		

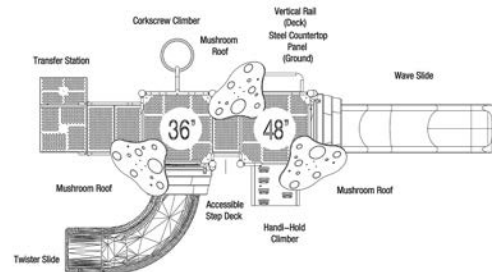

### Model #B303145

Age:	5 to 12	ASTM F1487:	✓
Play Events:	9	CAN/CSA-Z614:	✓
Use Zone:	32' x 23' (9.8 x 7.0m)	CPSC Pub.325:	✓
ADA:	✓		



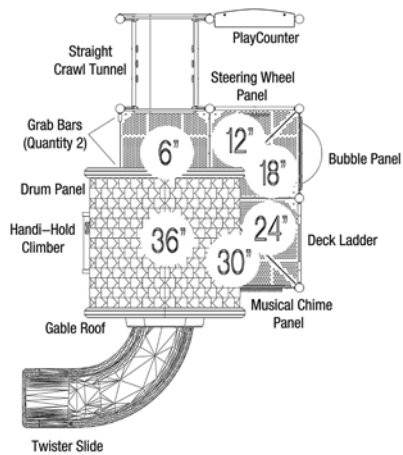

### Model #B302637R0

Age: 2 to 5 (1.5 to 5 CAN)  
 Play Events: 12  
 Use Zone: 27' x 23' (8.2 x 7.0m)

ASTM F1487: ✓  
 CAN/CSA-Z614: ✓  
 CPSC Pub.325: ✓





## Model #B302383

Age:	Age: 2 to 5 (1.5 to 5 CAN)	ASTM F1487:	✓
Play Events:	24	CAN/CSA-Z614:	✓
Use Zone:	29' x 28' (8.8 x 8.5m)	CPSC Pub.325:	✓
ADA:	✓		

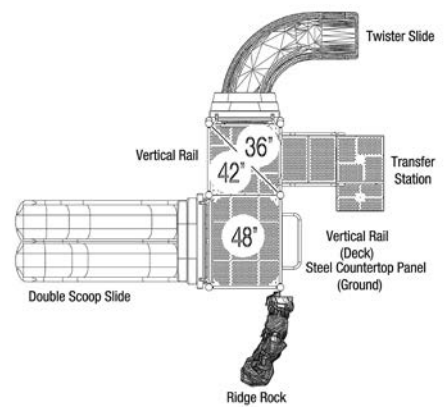



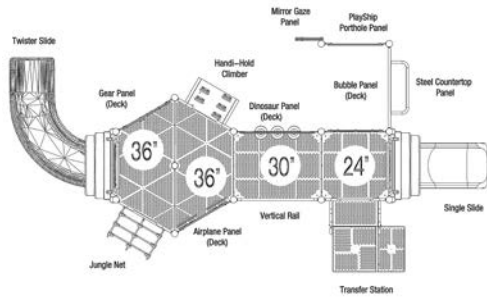

### Model #B303141

Age:	2 to 5 (1.5 to 5 CAN)	ASTM F1487:	✓
Play Events:	12	CAN/CSA-Z614:	✓
Use Zone:	34' x 23' (10.4 x 7.0m)	CPSC Pub.325:	✓
ADA:	✓		

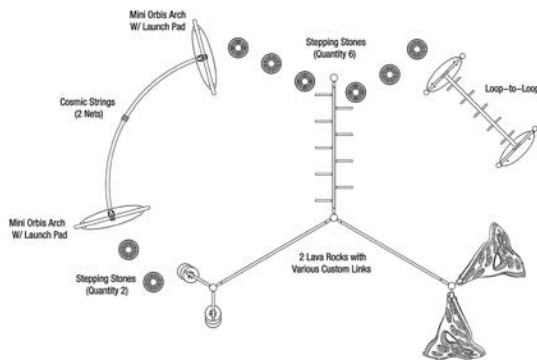

### Model #B303144

Age:	5 to 12	ASTM F1487:	✓
Play Events:	16	CAN/CSA-Z614:	✓
Use Zone:	40' x 33' (12.2 x 10.1m)	CPSC Pub.325:	✓
ADA:	✓		



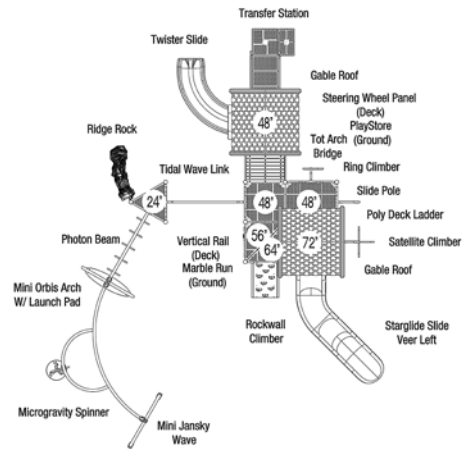

### Model #B303134

Age:	5 to 12	ASTM F1487:	✓
Play Events:	20	CAN/CSA-Z614:	✓
Use Zone:	44' x 38' (13.4 x 11.6m)	CPSC Pub.325:	✓
ADA:	✓		

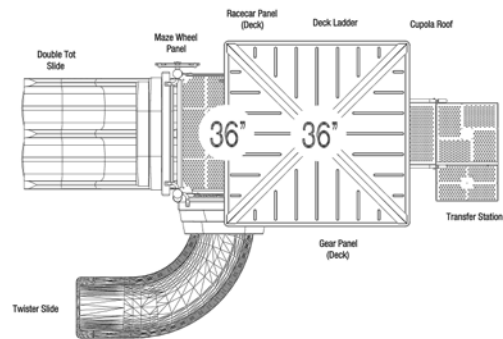

### Model #B303130

Age:	2 to 5 (1.5 to 5 CAN)	ASTM F1487:	✓
Play Events:	8	CAN/CSA-Z614:	✓
Use Zone:	28' x 22' (8.5 x 6.7m)	CPSC Pub.325:	✓
ADA:	✓		



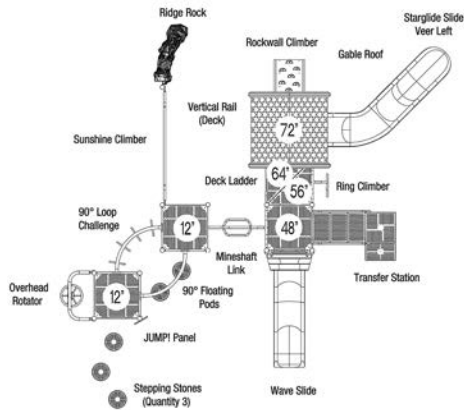

### Model #B303137

Age:	5 to 12	ASTM F1487:	✓
Play Events:	18	CAN/CSA-Z614:	✓
Use Zone:	39' x 38' (11.9 x 11.6m)	CPSC Pub.325:	✓
ADA:	✓		

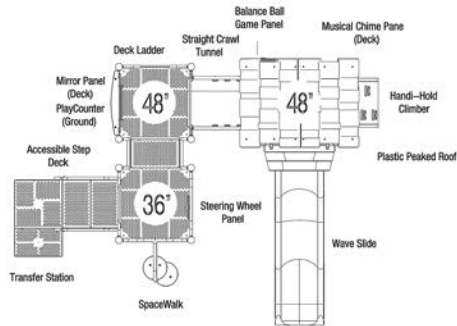

### Model #B303133

Age:	2 to 5 (1.5 to 5 CAN)	ASTM F1487:	✓
Play Events:	12	CAN/CSA-Z614:	✓
Use Zone:	28' x 24' (8.5 x 7.3m)	CPSC Pub.325:	✓
ADA:	✓		



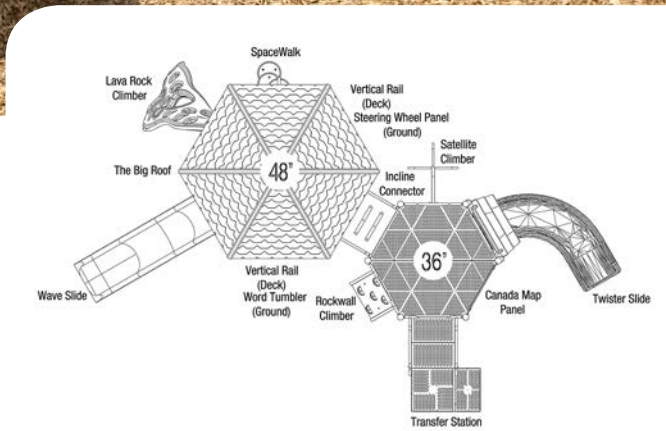

**Model #B301818**

Age:	Age: 2 to 5 (1.5 to 5 CAN)	ASTM F1487:	✓
Play Events:	13	CAN/CSA-Z614:	✓
Use Zone:	37' x 29' (11.3 x 8.8m)	CPSC Pub.325:	✓
ADA:	✓		







# MAX PLAYSTEEL





# MAXIMUM PLAY MAXIMUM FUN

Maximize versatility, accessibility, and component selection with PlaySteel Max, Henderson's premium play system. Max is large and in charge, and has our largest decks, our most durable posts, and our largest selection of play components.





# MAX PLAYSTEEL





# PlaySteel MAX

You can't go wrong with PlaySteel Max. It's our premier playground line that features all the durability, product selection, size, and accessibility you'll need. Maximize your play environment with PlaySteel Max today.



## Rust Protection

Henderson uses only premium quality galvanized steel, which offers superior rust protection. After welding we in-line zinc powder coat all welded areas and cut ends to offer you the best in anti-rust protection. Our process is superior to base coat or primer coats systems which are merely just another coat of paint.

## Design Help

Henderson Recreation sales reps have the knowledge and skill to guide you through the entire playground sales process. We can provide you with realistic 3D renderings and plan views to help understand the playground design you are purchasing.

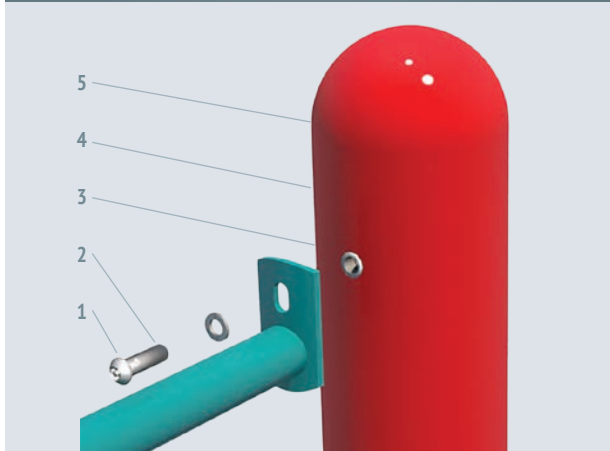

## Bolt-N-Go Technology

1. 304 alloy stainless steel tamper-resistant TORX® head bolts provide superior vandal resistance
2. Microspheres® thread-coating keeps bolts tight
3. Bolt-N-Go uprights arrive pre-threaded and ready to receive components
4. PlaySteel MAX uprights are 5" O.D. x 13 gauge galvanized steel for superior strength and durability
5. Durable cast-aluminum post caps



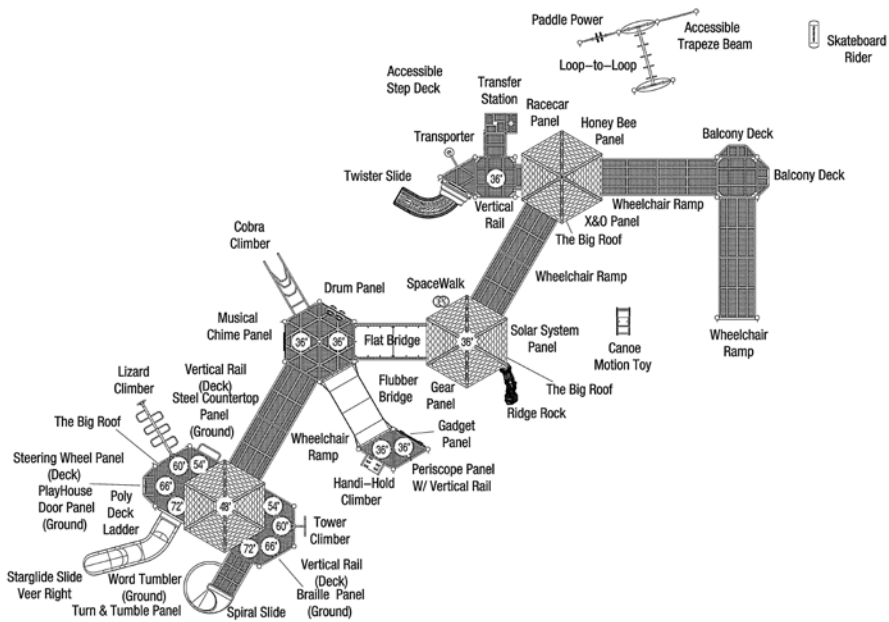





## Model #B501008R1

Age:	5 to 12	ASTM F1487:	✓
Play Events:	46	CAN/CSA-Z614:	✓
Use Zone:	87' x 73' (26.5 x 22.3 m)	CPSC Pub.325:	✓
ADA:	✓		





## Model #B501043R5

Age:	5 to 12	ASTM F1487:	✓
Play Events:	32	CAN/CSA-Z614:	✓
Use Zone:	52' x 40' (15.8 x 12.2m)	CPSC Pub.325:	✓



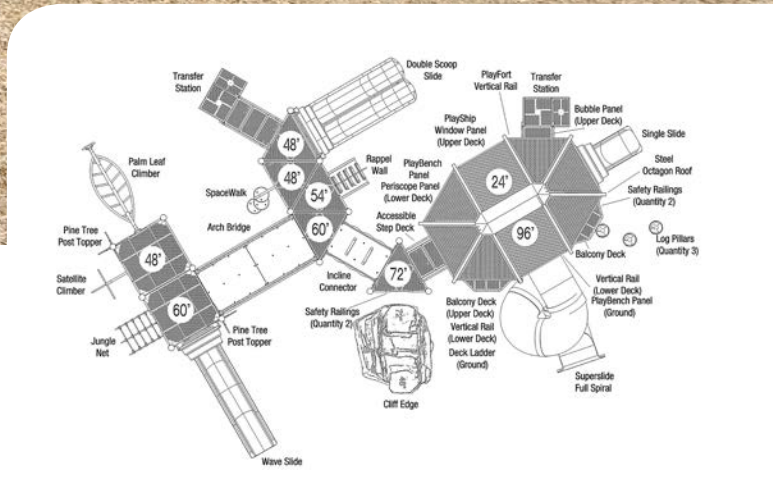





## Model #B500913R3

Age:	5 to 12	ASTM F1487:	✓
Play Events:	24	CAN/CSA-Z614:	✓
Use Zone:	53' x 52' (16.2 x 15.8m)	CPSC Pub.325:	✓
ADA:	✓		



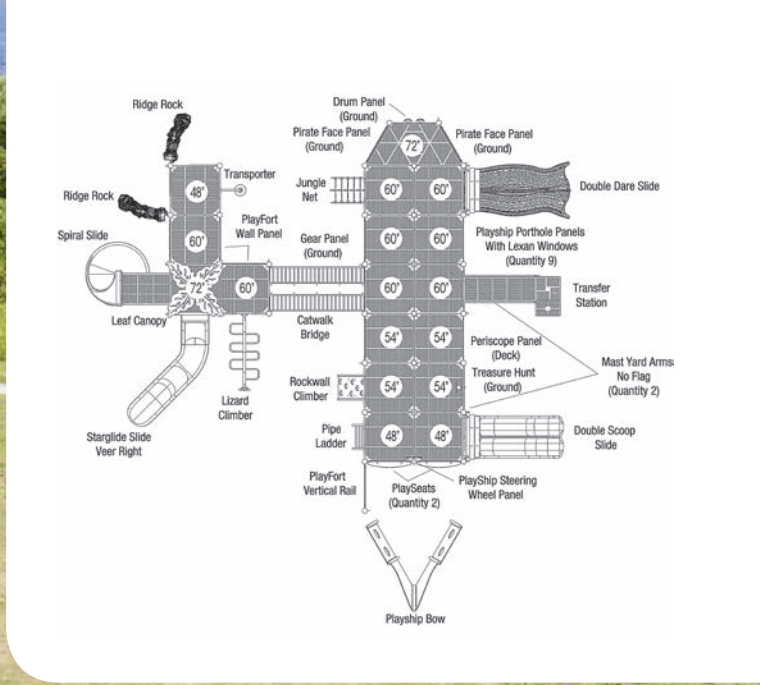



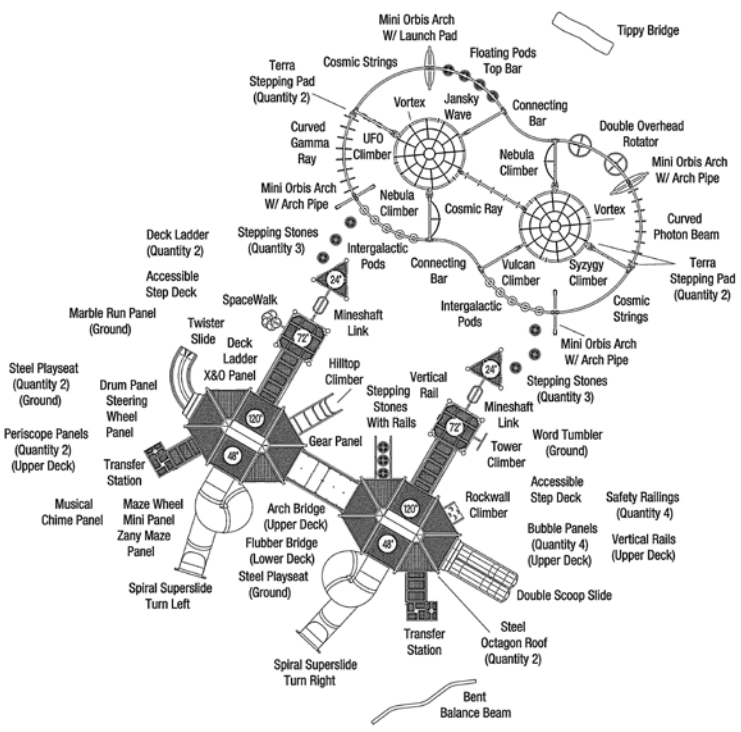





## Model #B500906R4

Age:	5 to 12	ASTM F1487:	✓
Play Events:	109	CAN/CSA-Z614:	✓
Use Zone:	88' x 66' (26.8 x 20.1m)	CPSC Pub.325:	✓
ADA:	✓		



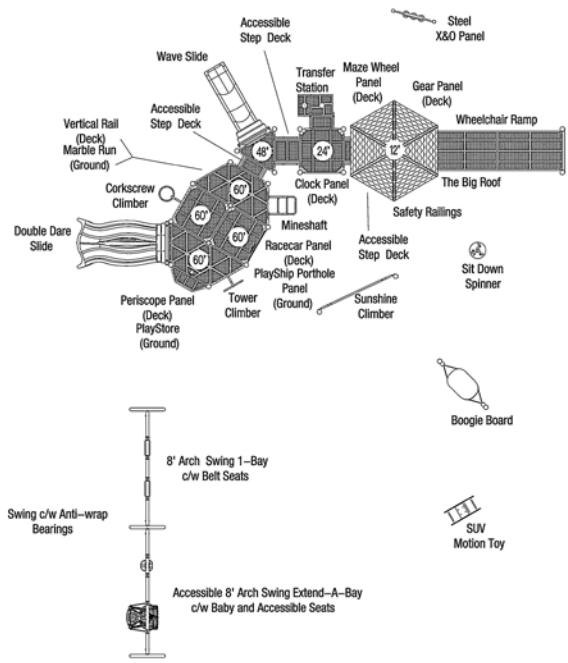

## Model #B50116R5

Age:	5 to 12	ASTM F1487:	✓
Play Events:	32	CAN/CSA-Z614:	✓
Use Zone:	67' x 53' (20.4 x 16.2m)	CPSC Pub.325:	✓
ADA:	✓		









## Model #B501330R1

Age:	5 to 12	ASTM F1487:	✓
Play Events:	22	CAN/CSA-Z614:	✓
Use Zone:	71' x 37' (21.6 x 11.3m)	CPSC Pub.325:	✓
ADA:	✓		



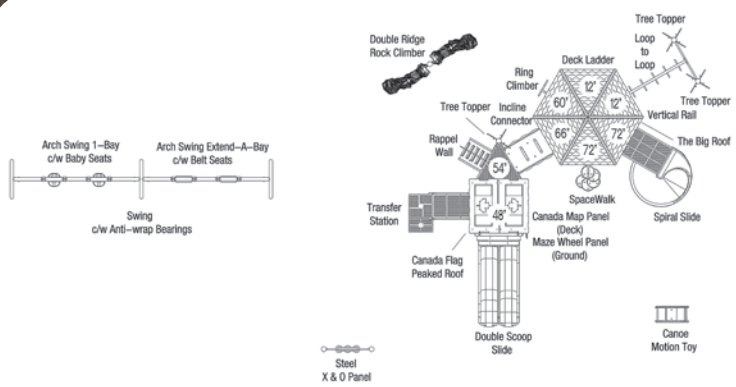





## Model #B500849R2

Age:	5 to 12	ASTM F1487:	✓
Play Events:	25	CAN/CSA-Z614:	✓
Use Zone:	89' x 53' (27.1 x 16.2m)	CPSC Pub.325:	✓
ADA:	✓		



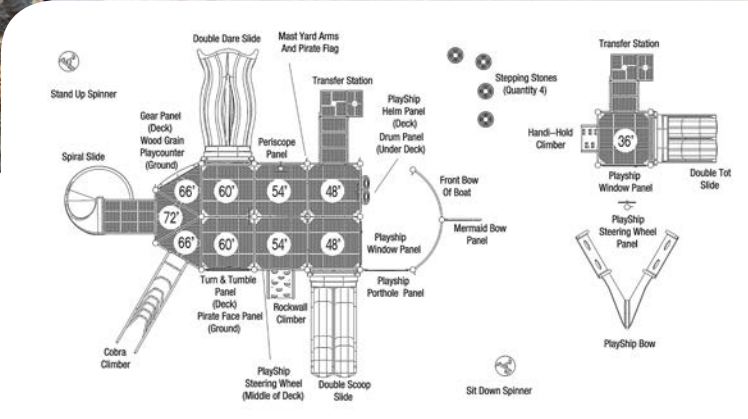



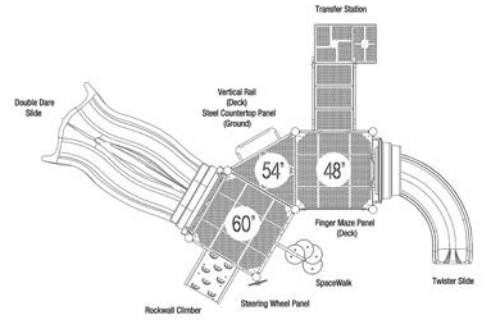

### Model #B501525

Age:	5 to 12	ASTM F1487:	✓
Play Events:	28	CAN/CSA-Z614:	✓
Use Zone:	35' x 28' (15.0 x 14.6m)	CPSC Pub.325:	✓
ADA:	✓		

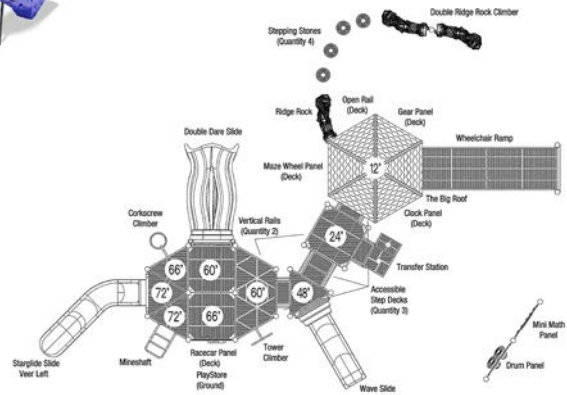

### Model #B501522

Age:	5 to 12	ASTM F1487:	✓
Play Events:	23	CAN/CSA-Z614:	✓
Use Zone:	51' x 45' (15.5 x 13.7m)	CPSC Pub.325:	✓
ADA:	✓		



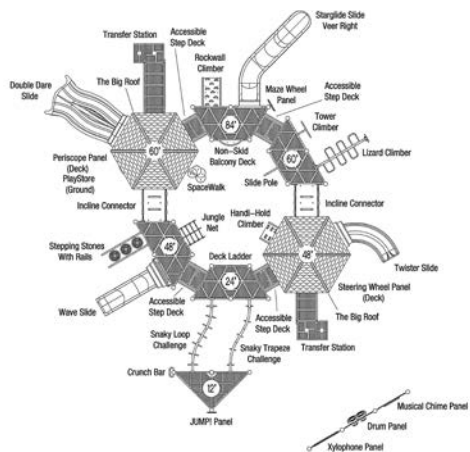

### Model #B501523

Age:	5 to 12	ASTM F1487:	✓
Play Events:	32	CAN/CSA-Z614:	✓
Use Zone:	56' x 50' (17.1x 15.2m)	CPSC Pub.325:	✓
ADA:	✓		

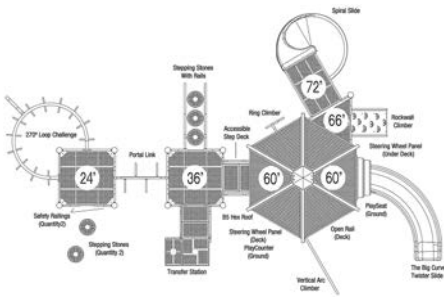

### Model #B501521

Age:	5 to 12	ASTM F1487:	✓
Play Events:	30	CAN/CSA-Z614:	✓
Use Zone:	45' x 33' (13.7 x 10.0m)	CPSC Pub.325:	✓
ADA:	✓		





## Model #B501336

Age: 2 to 5 (1.5 to 5 CAN)  
 Play Events: 10  
 Use Zone: 36' x 24' (11.0 x 7.3m)  
 ADA: ✓

ASTM F1487: ✓  
 CAN/CSA-Z614: ✓  
 CPSC Pub.325: ✓

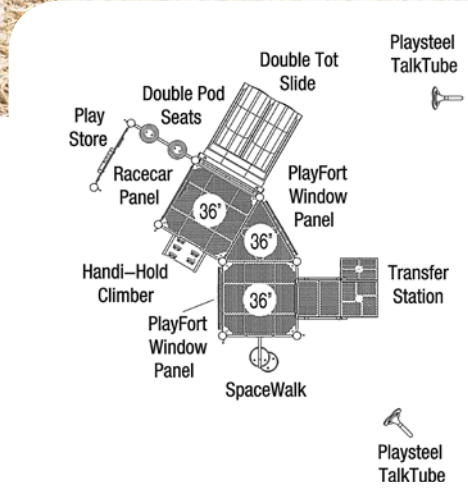



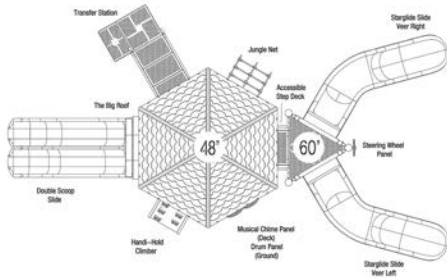

### Model #B501526

Age:	5 to 12	ASTM F1487:	✓
Play Events:	10	CAN/CSA-Z614:	✓
Use Zone:	39' x 28' (11.9 x 8.5m)	CPSC Pub.325:	✓
ADA:	✓		

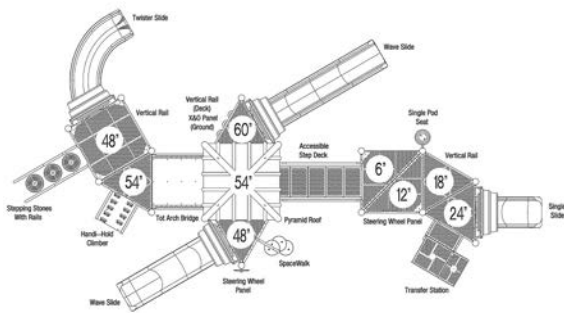

### Model #B501528

Age:	5 to 12	ASTM F1487:	✓
Play Events:	16	CAN/CSA-Z614:	✓
Use Zone:	48' x 33' (14.6 x 10.0m)	CPSC Pub.325:	✓
ADA:	✓		



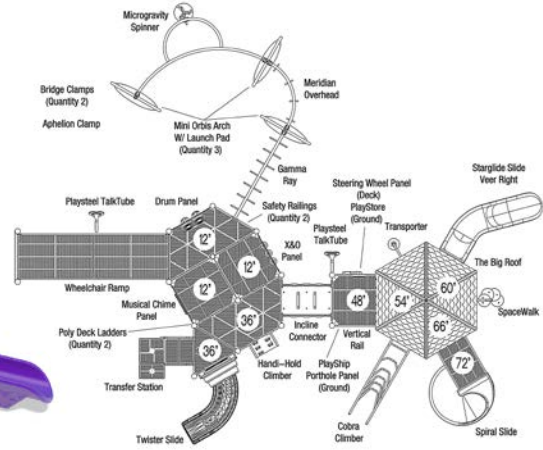

### Model #B501538

Age:	5 to 12	ASTM F1487:	✓
Play Events:	28	CAN/CSA-Z614:	✓
Use Zone:	49' x 48' (15.0 x 14.6m)	CPSC Pub.325:	✓
ADA:	✓		

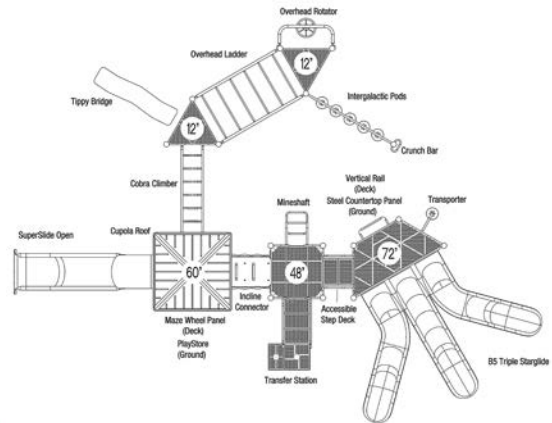

### Model #B501532

Age:	5 to 12	ASTM F1487:	✓
Play Events:	22	CAN/CSA-Z614:	✓
Use Zone:	54' x 44' (14.6 x 11.6m)	CPSC Pub.325:	✓
ADA:	✓		



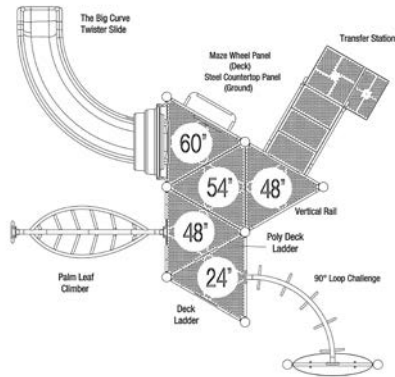

### Model #B501531

Age:	5 to 12	ASTM F1487:	✓
Play Events:	7	CAN/CSA-Z614:	✓
Use Zone:	29' x 29' (8.8 x 8.8m)	CPSC Pub.325:	✓
ADA:	✓		

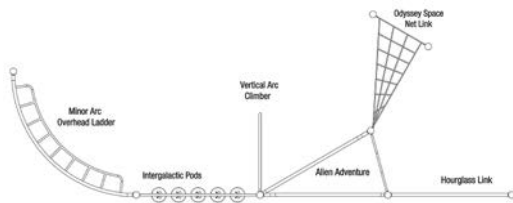

### Model #B501533

Age:	5 to 12	ASTM F1487:	✓
Play Events:	6	CAN/CSA-Z614:	✓
Use Zone:	45' x 25' (13.7 x 7.6m)	CPSC Pub.325:	✓
ADA:	✓		



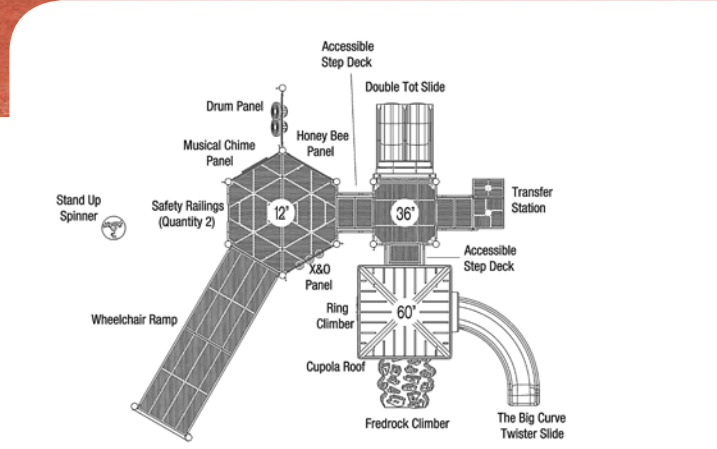

**Model #B501347R1**

- |              |                          |               |   |
|--------------|--------------------------|---------------|---|
| Age:         | 5 to 12                  | ASTM F1487:   | ✓ |
| Play Events: | 10                       | CAN/CSA-Z614: | ✓ |
| Use Zone:    | 41' x 34' (12.5 x 10.4m) | CPSC Pub.325: | ✓ |
| ADA:         | ✓                        |               |   |







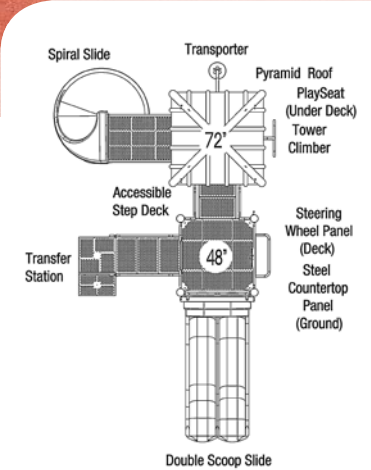

**Model #B501344**

- |              |                         |               |   |
|--------------|-------------------------|---------------|---|
| Age:         | 5 to 12                 | ASTM F1487:   | ✓ |
| Play Events: | 10                      | CAN/CSA-Z614: | ✓ |
| Use Zone:    | 33' x 26' (10.0 x 7.9m) | CPSC Pub.325: | ✓ |
| ADA:         | ✓                       |               |   |



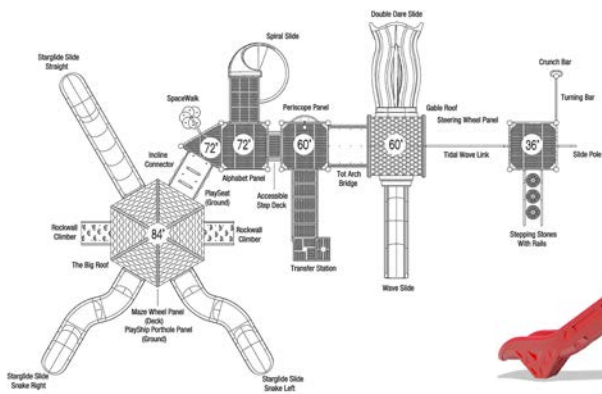

### Model #B501535

Age:	5 to 12	ASTM F1487:	✓
Play Events:	16	CAN/CSA-Z614:	✓
Use Zone:	60' x 45' (18.3 x 13.7m)	CPSC Pub.325:	✓
ADA:	✓		

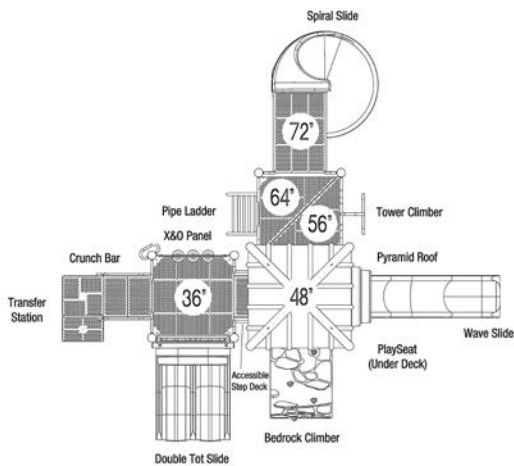

### Model #B501527

Age:	5 to 12	ASTM F1487:	✓
Play Events:	16	CAN/CSA-Z614:	✓
Use Zone:	34' x 33' (10.4 x 10.0m)	CPSC Pub.325:	✓
ADA:	✓		



# Mighty Shades



## Model #B302486R2

- Age: 5 to 12
- Play Events: 14
- Use Zone: 57' x 35' (17.4 x 10.7m)
- ADA: ✓
- ASTM F1487: ✓
- CAN/CSA-Z614: ✓
- CPSC Pub.325: ✓

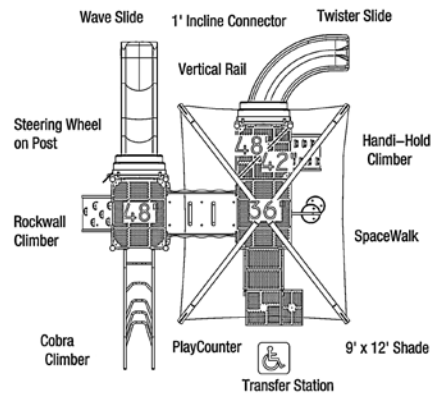



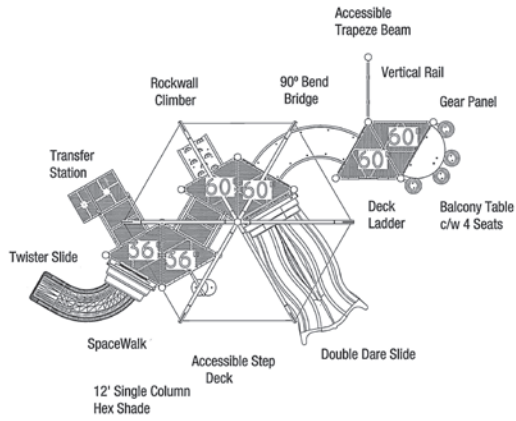

### Model #B501544

Age:	5 to 12	ASTM F1487:	✓
Play Events:	11	CAN/CSA-Z614:	✓
Use Zone:	40' x 31' (12.2 x 9.4m)	CPSC Pub.325:	✓
ADA:	✓		

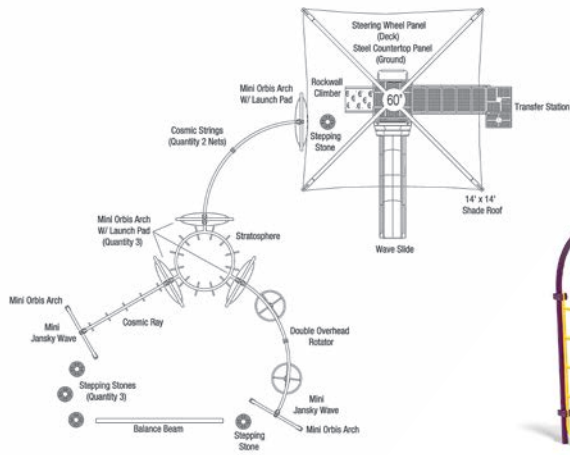

### Model #B303158

Age:	5 to 12	ASTM F1487:	✓
Play Events:	21	CAN/CSA-Z614:	✓
Use Zone:	48' x 41' (14.6 x 12.5m)	CPSC Pub.325:	✓
ADA:	✓		



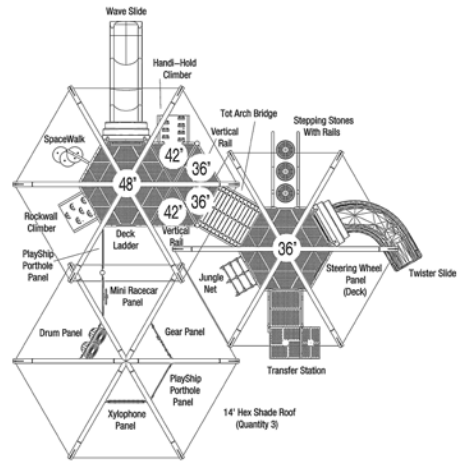

### Model #B303157

Age:	5 to 12	ASTM F1487:	✓
Play Events:	16	CAN/CSA-Z614:	✓
Use Zone:	38' x 36' (11.6 x 11.0m)	CPSC Pub.325:	✓
ADA:	✓		

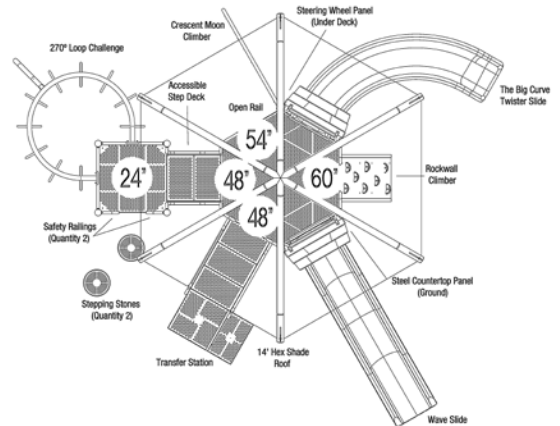

### Model #B303154

Age:	5 to 12	ASTM F1487:	✓
Play Events:	24	CAN/CSA-Z614:	✓
Use Zone:	34' x 31' (10.4 x 9.4m)	CPSC Pub.325:	✓
ADA:	✓		



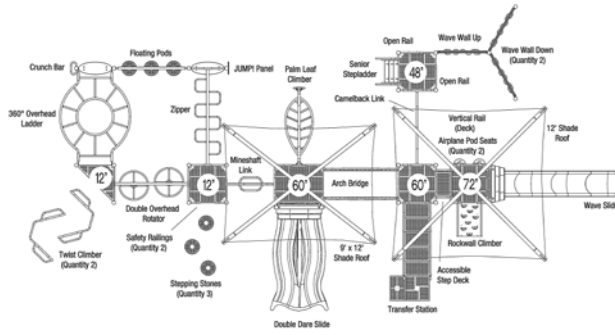

### Model #B303155

Age: 5 to 12  
 Play Events: 20  
 Use Zone: 60' x 37' (18.3 x 11.3m)  
 ADA: ✓

ASTM F1487: ✓  
 CAN/CSA-Z614: ✓  
 CPSC Pub.325: ✓

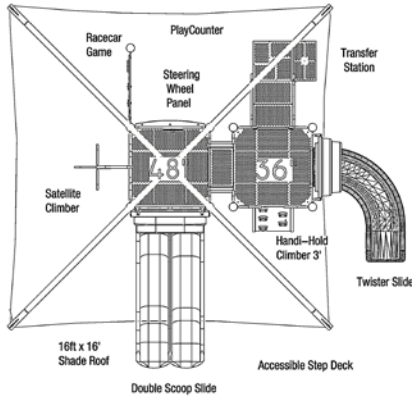

### Model #B501545

Age: 2 to 5 (1.5 to 5 CAN)  
 Play Events: 12  
 Use Zone: 29' x 29' (8.8 x 8.8m)  
 ADA: ✓

ASTM F1487: ✓  
 CAN/CSA-Z614: ✓  
 CPSC Pub.325: ✓







# PlaySteel Max & Fit Components



## Challenging and Fun

Children learn to challenge not only their bodies but their minds as well. Traverse amazing climbers, cross difficult overheads, challenge friends on maze wheels or the boogie board. So many events and fun things to do, children will never realize they are expanding their minds and exercising their bodies.

## Where Friends Come Together

Playgrounds are where communities connect. It's the place to bring your friends or meet new ones. Lasting friendships are often built here. Who remembers those wonderful games of tag as a kid?



## Social and Quiet Spaces

Lots of components provide quiet places to escape the hustle and bustle of the main playground. Other components are magnets for kids to gather like the playcounter shown here. Take a look at our component sections to see the play events you're interested in for your playground.







### Veering Starglide Slide

A popular left- or right-veering slide.  
Deck Heights- 5,6,7,8ft (1.5,1.8,2.1,2.4m)



### Starglide Slide Straight

A straight, but versatile slide.  
Deck Heights- 3,4,5,6,7,8ft (0.9,1.2,1.5,1.8,2.1,2.4m)



### Starglide Slide Turn Left or Right

The dramatic curve on this slide delivers the fun.  
Deck Heights- 5,6,7,8ft (1.5,1.8,2.1,2.4m)



### Starglide Slide Veer Left or Right

A versatile left- or right-veering slide.  
Deck Heights- 5,6,7,8ft (1.5,1.8,2.1,2.4m)



### Starglide Slide Snake Left or Right

This snake-curved slide is popular with kids.  
Deck Heights- 5,6,7,8ft (1.5,1.8,2.1,2.4m)



### Single Stainless Slide

A traditional straight slide with a durable stainless steel slide bed.  
Deck Heights- 3,4,5,6ft (0.9,1.2,1.5,1.8m)





### Double Stainless Slide

Double the fun with two durable stainless steel slides.  
Deck Heights- 3,4,5ft (0.9,1.2,1.5m)



### Wavy Stainless Slide

A durable stainless steel slide with a wavy slide bed.  
Deck Heights- 5ft (1.5m)



NEW

### Triple Starglide

A super cool triple slide that children can race down to the bottom.  
Deck Heights- 5,6,7,8ft (1.5,1.8,2.1,2.4m)



### Big Curve Slide

This right-curving poly slide adds an exciting twist to traditional playground design.  
Deck Heights- 5ft (1.5m)



### 3ft Twister Slide

A small, right-turning poly slide, ideal for a preschool play structure.  
Deck Heights- 3ft (0.9m)



### 4ft Twister Slide

A mid-size twister slide; suitable for all ages.  
Deck Heights- 4ft (1.2m)





### Double Dare Slide

Two distinct rides in one fantastic slide.  
Deck Heights- 5ft (1.5m)

---



### Double Scoop Slide

Two slides in one are fun for playmates and encourage cooperative play.  
Deck Heights- 4ft (1.2m)

---



### Spiral Slide

A spiral slide is always a playground favorite. This one-piece poly slide includes custom deck and rails.  
Deck Heights- 6ft (1.8m)

---



### Wave Slide

A rippled slide bed gives children a new and different sliding experience. Deck Heights- 4,5,6

---



### Double Tot Slide

A gentle, two-tot poly slide. Side-by-side slides are great for encouraging cooperative play and friendly competition.  
Deck Heights- 3ft (0.9m)

---



### Single Slide 2ft

The perfect low level slide for the little adventurers.  
Deck Heights- 2ft (0.6m)

---





### SuperSlide Curved Right

Kids love the full-tube entrance combined with an open, curving slide bed.

Deck Heights- 4,5,6,7ft (1.2,1.5,1.8,2.1m)



### SuperSlide Curved Left

An awesome slide with a fully enclosed entrance for safety.

Deck Heights- 4,5,6,7ft (1.2,1.5,1.8,2.1m)



### SuperSlide Open

A full-tube entrance and an open slide bed add excitement to this sliding experience. Deck

Deck Heights- 4,5,6,7ft (1.2,1.5,1.8,2.1m)



### SuperSlide Spiral

A thrilling, fully-enclosed poly spiral slide.

Deck Heights- 7,8ft (2.1,2.4m)



### Open SuperSlide

Based on Henderson's signature SuperSlide, this slide has a fully open tube. Not available in Canada.

Deck Heights- 4,5,6,7ft (1.2,1.5,1.8,2.1m)



### Triple Slide

Three different slides in one make this one a triple hit.

Deck Heights- 6ft (1.8m)





### Ridge Rock Climber

Our plastic Ridge Rock Climber offers a great rock climbing experience at a fraction of the cost of real concrete rock climbing events.  
Deck Heights- 2,3,4ft (0.6,0.9,1.2m)



### Ridge Rock Climber to Post

The Ridge Rock Climber can be attached to a post as a freestanding component or as climbing event on a composite structure.



### Lava Rock Climber

The twisting flowing shape of the Lava Rock Climber provides an extra climbing challenge children will enjoy conquering.  
Deck Heights- 4ft (1.2m)



### Horseshoe Net Climber

A wall of climbing excitement for multiple users. Two cable climbing nets provide a large climbing area. May be used freestanding or adjoining a play structure. Decks not required.



### Lunar Climbing Wall

Deck Heights- none  
A crescent-shaped cable climbing wall for multiple users. For freestanding use. Decks not required.



### Lunar Climbing Wall (to Decks)

A crescent-shaped cable climbing wall, ideal for locations where many children play.  
Deck Heights- 5ft (1.5m)





### Spider Net

A flexible wall of cable. Available for use freestanding or adjoining a play structure. Decks are not required.

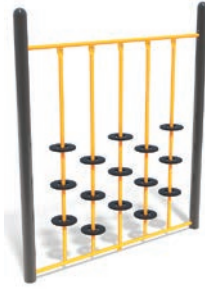

### Intergalactic Pods

A wall of climbing fun with non-skid plastic climbing pods. This climber may be used freestanding or adjoining a play structure. Decks not required.



### Jungle Net

A climbing net made from flexible cable.  
Deck Heights- 3,4,5,6ft (0.9,1.2,1.5,1.8m)



### Spacewalk

A spiralling steel climber with non-skid plastic steps.  
A gentle beginners' climber.  
Deck Heights- 3,4,5,6,7ft (0.9,1.2,1.5,1.8,2.1m)



### Transporter

A vertical steel climber with non-skid plastic climbing discs.  
Deck Heights- 3,4,5,6,7ft (0.9,1.2,1.5,1.8,2.1m)



### Spacewalk (to post)

This spiralling pod stair adds extra functionality to other climbing events.  
Deck Heights- 3,4,5,6,7ft (0.9,1.2,1.5,1.8,2.1m)



### Meteor Burst

Double non-skid pod climbing adventure.  
Deck Heights- 3,4,5,6,7ft (0.9,1.2,1.5,1.8,2.1m)





### Hill Top Climber

A gently sloped steel climber with shallow rungs for extra challenge.  
Deck Heights- 2,3,4ft (0.6,0.9,1.2m)



### Lizard Climber

An all-steel climber with evenly spaced rungs both front and back.  
Deck Heights- 3,4,5ft (0.9,1.2,1.5m)



### Fredrock Climber

A roto-molded plastic climber offering a solid climbing surface.  
Deck Heights- 4,5ft (1.2,1.5m)



### Handi-Hold Climber

An HDPE non-skid climber with climbing cutouts.  
Deck Heights- 3,4,5,6,7ft (0.9,1.2,1.5,1.8,2.1m)



### Mineshaft

An all-steel climber with evenly spaced rungs at front and back.  
Deck Heights- 3,4,5,6,7ft (0.9,1.2,1.5,1.8,2.1m)



### Pipe Ladder

A classic steel playground ladder.  
Deck Heights- 3,4,5,6,7ft (0.9,1.2,1.5,1.8,2.1m)

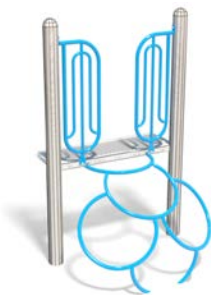

### Bubble Climber

Bursting with bubbles, this whimsical steel climber looks great on any playground.  
Deck Heights- 3ft (0.9m)



### Slide Pole

A classic steel play component for sliding and climbing.  
Deck Heights- 3,4,5,6,7ft (0.9,1.2,1.5,1.8,2.1m)



### Rockwall Climber

An HDPE non-skid climbing surface with ergonomically designed climbing holds.  
Deck Heights- 3,4,5,6,7ft (0.9,1.2,1.5,1.8,2.1m)





### Stepping Stones Climber

A pod based climbing experience with support bars.  
Deck Heights: 3,4ft (0.9,1.2m)

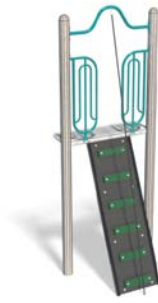

### Rappel Wall

A HDPE non-skid climbing surface with cleats and a cable rope for climbing up and rappelling down.  
Deck Heights: 3,4,5,6,7ft (0.9,1.2,1.5,1.8,2.1m)



### Rudder Climber

HDPE plastic cut outs on a vertical steel climbing frame provides a rewarding but challenging climb to the top.  
Deck Heights: 3,4,5,6,7ft (0.9,1.2,1.5,1.8,2.1m)



### Satellite Climber

Alternating rectangular rungs distinguish this all-steel vertical climber.  
Deck Heights: 3,4,5,6,7ft (0.9,1.2,1.5,1.8,2.1m)



### Tower Climber

A challenging ladder-style climber with alternating rungs.  
Deck Heights: 3,4,5,6,7ft (0.9,1.2,1.5,1.8,2.1m)

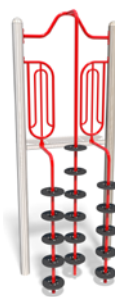

### Meteor Shower

This set of three climbers can be enjoyed in many different ways. Equipped with non-skid plastic climbing disks.  
Deck Heights: 3,4,5,6,7ft (0.9,1.2,1.5,1.8,2.1m)



### Corkscrew Climber

Children enjoy this two-in-one steel climber and twirling slide ride.  
Deck Heights: 3,4,5,6,7ft (0.9,1.2,1.5,1.8,2.1m)



### Ring Climber

A series of metal rings provide a fun and exciting way to climb to different decks levels.  
Deck Heights: 3,4,5,6,7ft (0.9,1.2,1.5,1.8,2.1m)



### Leaf Climber

A playful and challenging steel climber, ideal for thematic play spaces.  
Deck Heights: 4,5ft (1.2,1.5m)





NEW

### Alien Adventure Climber

A unique climber that kids can climb over, under or even sideways on this challenging new climbing component. Includes alien themed climbing panel inserts.

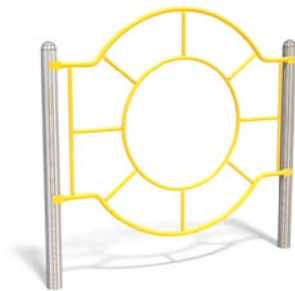

### Sunshine Climber

A sunny steel climber for multiple users. For use freestanding or adjoining a play structure.



NEW

### Vertical Arc Climber

A vertical ladder that will challenge advanced climbers as it arches towards the deck.  
Deck Heights- 4,5,6ft (1.2,1.5,1.8m)



NEW

### Crescent Moon Climber

A vertical climbing arch that challenges the best climbers. A great addition to any playground. Made from HDPE non-skid plastic that adds extra traction for climbing and gripping.  
Deck Heights- 4,5,6ft (1.2,1.5,1.8m)

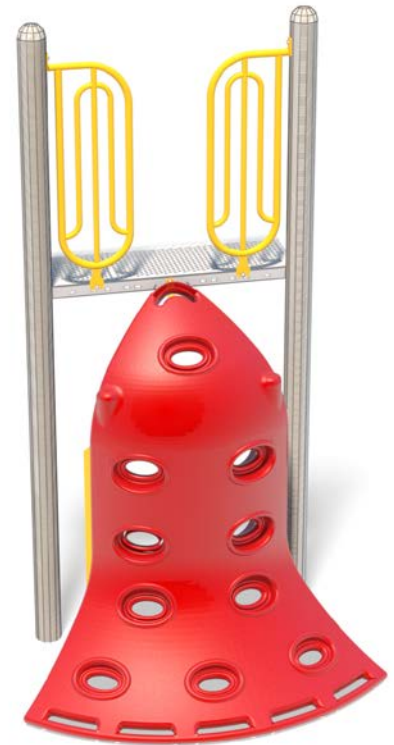

### Cliff Hanger

A roto-molded plastic climber with a unique shape kids love. Includes numerous cutouts for ample climbing options.  
Deck Heights- 6ft (1.8m)



NEW



### Double Wave Wall

Two vertical wave walls allow kids to climb this fun and challenging climber on either side.  
Deck Heights: 4,5,6ft (1.2,1.5,1.8m)



### Bedrock Climber

A roto-molded rock climber that provides a challenging arched climb to the deck.  
Deck Heights: 3,4ft (0.9,1.2m)

### Wormhole Climber

With so many options for use, it's no wonder children love this flexible cable climbing cylinder. Features three connection nodes for the attachment of arches and play components. Maintains open sight lines for ease of supervision.



### Intergalactic Pods

A wall of climbing fun with non-skid plastic climbing pods. This climber may be used freestanding or adjoining a play structure. Decks not required.



### Tidal Wave

Link deck to ground level with this challenging, multi-user climber.  
Deck Heights: 4,5ft (1.2,1.5m)



### Cobra Climber

This steel climber with deep rungs and side rails helps boost climbing confidence.  
Deck Heights: 3,4,5,6,7ft (0.9,1.2,1.5,1.8,2.1m)





NEW

### Hourglass Link

A challenging vertical climbing event with moving components. A great way for children to develop their climbing skills in a fun way.



### Tidal Wave Link

Deck Heights- Links two decks separated by a 2' variance.



### Portal Link

Challenging deck-to-deck connector. Connects two decks separated by a 1' (305mm) variance.



### Rib Cage Link

With alternating ribs, links two decks at the same height.





NEW

### "S" Link

An alternating climbing event that is most often used low to the ground.



### Twisty Link

Deck Heights- Connects two decks at the same height.



### Camelback Link

Links two decks separated by a 1' (305mm) variance.



### Vertical Net Link

Connects to decks via a fun vertical climbing net.



NEW

### Triangle Link

Children can challenge themselves to climb through or over the hanging triangle components.



### Wavy Link

Connects two decks at the same height.





NEW

### Curly Link

Four HDPE disks with rings for traction provide a fun way to elevate children up two feet to the next level deck.



### Tidal Wave Link to Post

This link connects the tidal wave to a post instead of another deck making this link more of a climbing event.

Deck Heights: 2,3,4,5,6ft (0.6,0.9,1.2,1.5,1.8m)



### Leapfrog Link

Non-skid plastic lily pads on a serpentine rail. Links two 1' (305mm) decks. Also available freestanding.



### Crooked Net

Versatile component connects deck-to-deck and ground-to-deck. Links two 4' (1219mm) or 5' (1524mm) decks.



NEW

### Odyssey Space Net Link

This twisting net allows a child to traverse from the ground to the top of the net or to a deck in a more challenging way.





NEW

### Boogie Board

Heavy duty flexible rubber with a small side to side sway makes this Boogie Board an exciting but challenging component to stand up on. Or kids can just chill out on it and use it like a hammock.



### Mineshaft Link

A space-saving deck-to-deck connector. Links two decks separated by a 3' (914mm) or 4' (1219mm) variance.



### Cobra Link

All the fun of the climber for use between decks. Links two decks separated by a 4' (1219mm) variance.

NEW

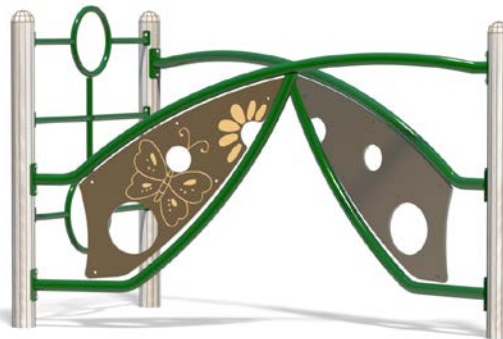

### Nature Adventure Climber

A unique climber that kids can climb over, under or even sideways on this challenging new climbing component. Includes nature themed climbing panel inserts.





NEW

### Hourglass Spinner

Definitely one of our most popular playground components. Kids absolutely love the Hourglass Spinner. Kids often work together and take turns to spin each other.

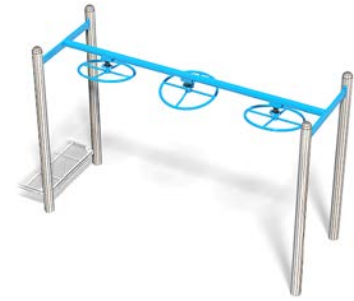

### Triple Overhead Rotator

Ideal for busy playgrounds. Extensively tested for superior performance and durability. Available freestanding or for 6' (152mm) through 2' (610mm) decks.



### Double Overhead Rotator

A second moving wheel adds challenge. Extensively tested for superior performance and durability. Available freestanding or for 6' (152mm) through 2' (610mm) decks.



### 20ft Track Ride

Momentum is easily maintained over 20' (6096mm) length. Available freestanding or for 6' (152mm) through 2' (610mm) decks. Maximum height 76' (1950mm).



### 12ft Track Ride

Available freestanding or for 6' (152mm) through 2' (610mm) decks. Maximum height 76' (1950mm).



### Track Ride

An 8' (2438mm) long suspended slide ride. Available freestanding or for 6' (152mm) through 2' (610mm) decks.



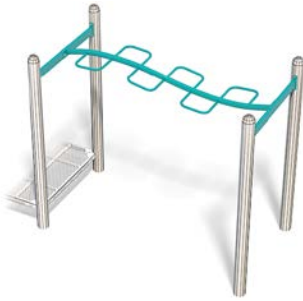

### Rippled Zipper

Staggered rungs and a rippled rail for added challenge. Available freestanding or for 6' (152mm) through 2' (610mm) decks.



### Zipper Overhead

Staggered rungs add challenge to this overhead play activity. Available freestanding or for 6' (152mm) through 2' (610mm) decks.



### Loop-to-Loop

Stationary round loops are suspended from a straight beam. Available freestanding or for 6' (152mm) through 2' (610mm) decks.



### Snaky Trapeze Challenge

Swinging triangular rungs are suspended from a serpentine beam for extra challenge. Available freestanding or for 6' (152mm) through 2' (610mm) decks.



### Snake Rail Overhead

A challenging overhead activity. Available freestanding or for 6' (152mm) through 2' (610mm) decks.



### Snaky Loop Challenge-Right

A serpentine beam with stationary loops. Available freestanding or for 6' (152mm) through 2' (610mm) decks.

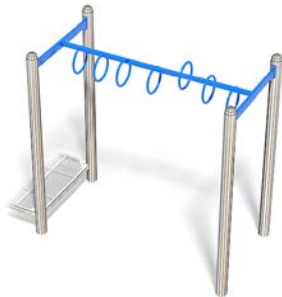

### Loop Challenge

Staggered loops increase the challenge factor of this activity. Available freestanding or for 6' (152mm) through 2' (610mm) decks.



### Snaky Loop Challenge-Left

A serpentine beam with stationary loops that curves to the left. Available freestanding or for 6' (152mm) through 2' (610mm) decks.



### Double Trapeze Challenge

Two rows of swinging trapeze rings are a challenging favorite. Available freestanding or for 6' (152mm) through 2' (610mm) decks.





### Trapeze Challenge

Swinging trapeze rings on a straight beam. Available freestanding or for 6' (152mm) through 2' (610mm) decks.



### 270° Loop Challenge

A smart way to add a large overhead activity to any play structure. Requires only one deck. May be used with 6' (152mm) through 2' (610mm) decks.



### 90° Trapeze Challenge

Swinging trapeze rings on a curved beam make a perfect deck-to-deck connector. Available freestanding or for 6' (152mm) through 2' (610mm) decks.



### 90° Loop Challenge

Stationary round loops are suspended from a curved beam. For 6' (152mm) through 2' (610mm) decks.



### X-Loop Overhead

A large, multi-user activity. Rings are suspended from crossing beams, making it a challenging overhead trek.



### Twin Track Ride

Double the fun with two 8' (2438mm) long rides.

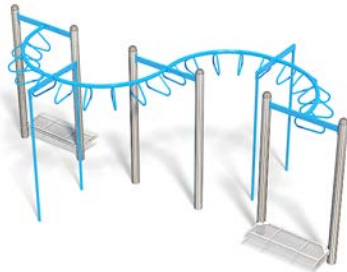

### Shooting Star Overhead

Children can really challenge themselves with this extra-long overhead fitness track. Available freestanding or for 6' (152mm) through 2' (610mm) decks.



### Crunch Bar

A simple add-on that's big on fun and fitness. Attaches to any post, making the most of your playground.



### Half Moon Overhead

Stationary loops on a curved beam. An ideal deck connector. For 6' (152mm) through 2' (610mm) decks.





### Double Snake Rail

This unique overhead activity challenges children to play in a new way. Available freestanding or for 6' (152mm) through 2' (610mm) decks.



### 6ft Overhead Ladder

A traditional overhead ladder, ideal for mastering the art of brachiation. Available freestanding or for 6' (152mm) through 2' (610mm) decks.



### 6ft Loop-to-Loop

Stationary round loops are suspended from a straight beam. This activity is available freestanding or for 6' (152mm) through 2' (610mm) decks.



### 6ft Triangle Rung

A shorter space saving version of the Triangle Rung Climber designed for smaller spaces.



### Wavy Overhead Ladder

A classic overhead ladder with a challenging wave. Available freestanding or for 6' (152mm) through 2' (610mm) decks.



### Spinner

Another version of the popular spinner. This one is capable of handling two children at a time.



### Overhead Rotator

The new playground favorite. Extensively tested for superior performance and durability. For 6' (152mm) through 2' (610mm) decks.



### Snaky Overhead Ladder

Snaky rails add extra challenge to this overhead ladder. Available freestanding or for 6' (152mm) through 2' (610mm) decks.



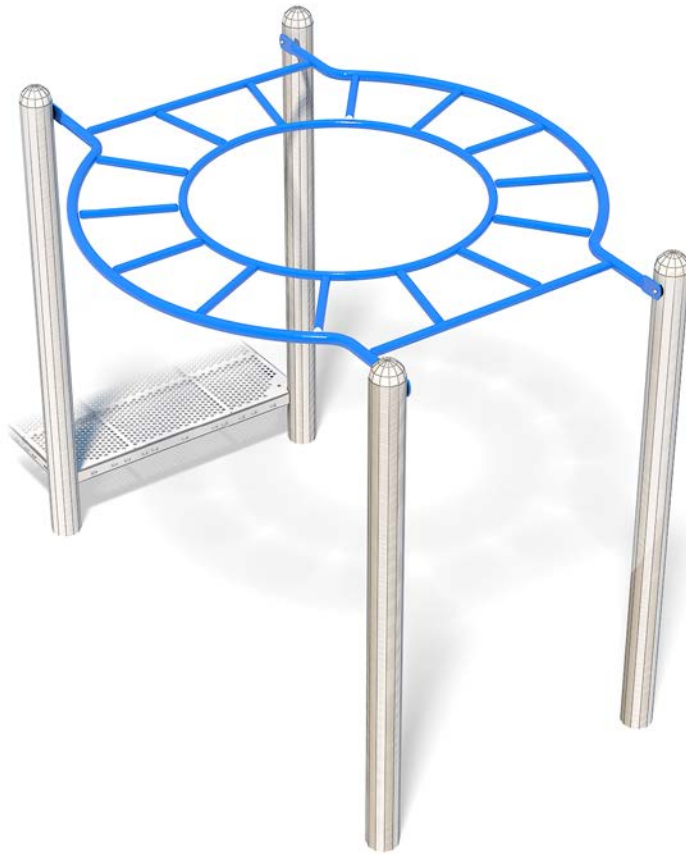

### 360° Overhead Ladder

This is a challenging, extra-long overhead ladder. Children have plenty of room to challenge themselves on this activity. Available freestanding or for 6' (152mm) through 2' (610mm) decks.



### Overhead Ladder

A traditional overhead ladder, ideal for mastering the art of brachiation.



### Triangle Rung Overhead

A row of suspended triangular rungs on a straight beam. Available freestanding or for 6' (152mm) through 2' (610mm) decks.



### 180° Loop Challenge

Stationary loops on a curved beam. An ideal deck connector. For 6' (152mm) through 2' (610mm) decks.

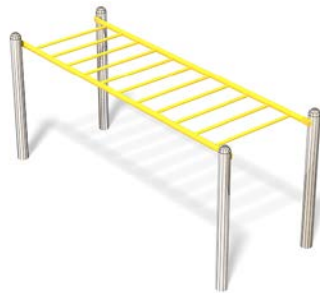

### 12ft Overhead Ladder

An accessible 12ft (3.7m) long overhead ladder that can be lowered so children in wheelchairs can access the rungs.

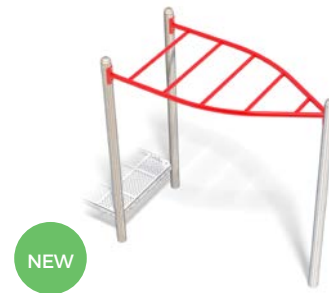

NEW

### Wishbone Overhead

A cost effective yet challenging overhead that tapers to one post. Children need to plan ahead to master this overhead activity.





### Minor Arc Overhead Ladder

A fun curvy overhead traverse that arcs between two upright posts. Looks way cooler than traditional overhead climbers and the arc adds to the challenge.



### Turning Bar

A simple activity that's big on fun and fitness. Various heights available. Available freestanding or adjoining a play structure.



### Accessible Trapeze Beam

Moving grips challenge children of all abilities. Available freestanding or adjoining a play structure.



### Paddle Power

Turning wheels are fun for children of all abilities. Available freestanding or adjoining a play structure.





NEW

### Inclined Board

A fun and creative climbing and balancing board children can use to challenge their abilities.



### Stepping Stones

A roto-molded plastic pod great to link together into a series of stepping stones. Available in 6', 12', 18', 24' and 30' (0.15, 0.3, 0.46, 0.61, 0.76m) and heights.



### Snake Balance Beam

Two-in-one includes overhead activity and balance beam. Links two decks at the same height. Also available freestanding or adjoining a play structure.

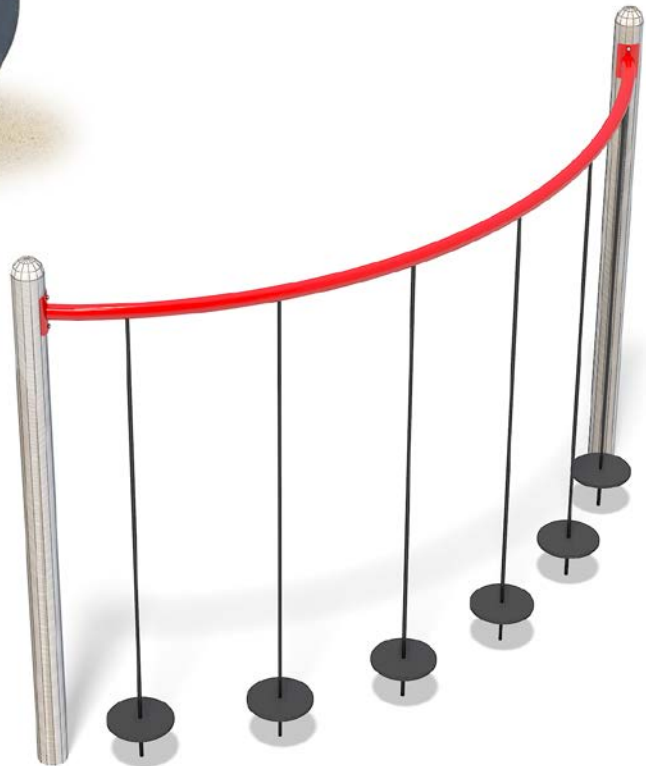

NEW

### Cable Pod Challenge

A popular balance activity to traverse on its own or between two decks. Also can be used in functionally linked layouts.





### Floating Pods

With swinging, non-skid plastic step stones. Links two decks at the same height. Also available freestanding.



### Floating Pods (to Post)

Kids love movement and challenge, making this wiggly balance activity a proven winner.



### 90° Floating Pods

A curved version of our popular balance builder. Also available freestanding or adjoining a play structure.



### 1ft Incline Floating Pods

Links two decks separated by a 1' (610mm) variance or links deck to ground.



### Snaky Floating Pods

Side-to-side stepping action develops balance. Links two decks at the same height. Also available freestanding or adjoining a play structure.

### Tippy Bridge

This fun and exciting Tippy Bridge is a fun way to improve a child's balance. Big enough to have more than one user, this cool component will definitely challenge one's balance.





NEW

### Cargo Net

A two sided climbing net that can be accessed from the deck or the ground. Children can climb the net or traverse across it between the decks.



### Wheelchair Ramp

An accessible wheelchair ramp with a 1ft rise between two decks.



### Wheelchair Ramp-Barriers

An accessible wheelchair ramp with a 1ft rise between two decks.



### Catwalk Bridge

Connects two decks at same height with a narrow bridge crossing.

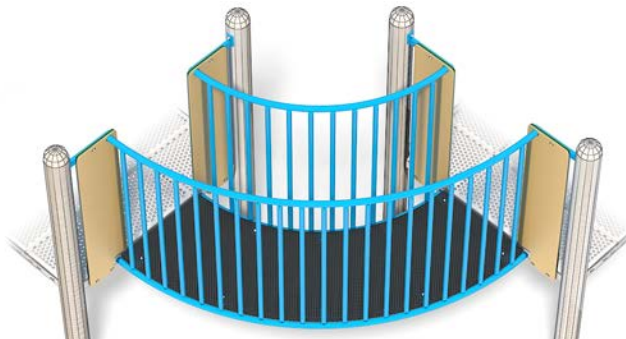

### 90° Bend Bridge

Connects two decks at same height at 90° from each other. This bridge is a great way to add twists and turns on the playground. Combine with the 45° Crawl Tunnel for added fun.



### Flat Bridge

A wheelchair accessible bridge that connects two decks at same height.



### Tot Arch Bridge

Connects two decks at same height with a gentle and fun arch children can traverse.

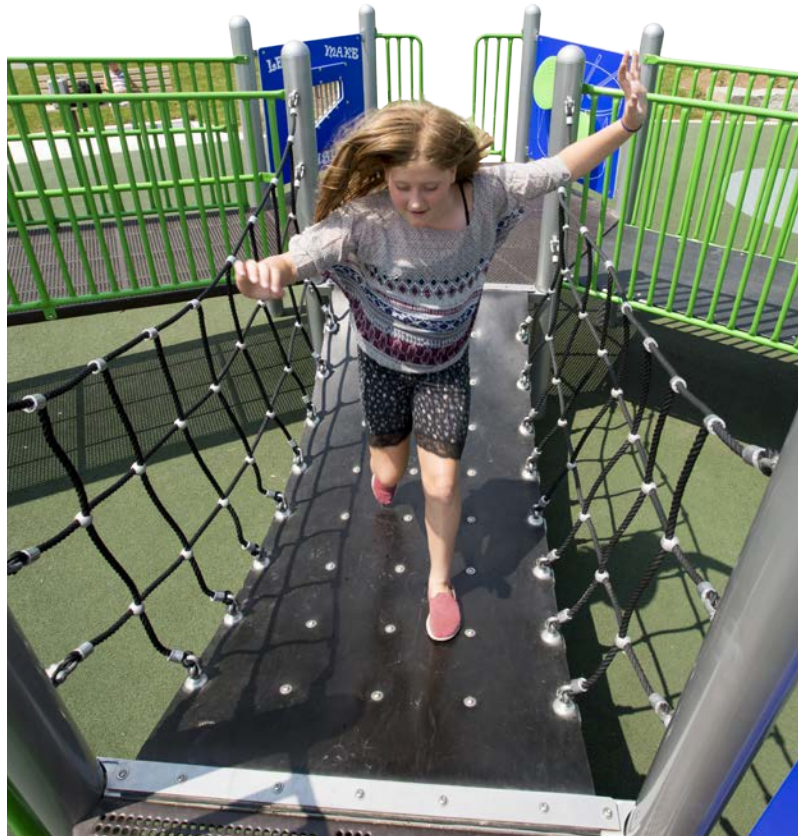

### Flubber Bridge

A wiggly, swaying, moving and dynamic bridge that connects two decks together.



### Arch Bridge

Connects two decks at same height with a long and gentle arch children can traverse.



NEW

### 1ft Incline Connector

Connects two decks separated by a 1ft elevation change.





### 2ft Rise Crawl Tunnel

Features a gentle 2' (610mm) rise to connect two decks. This large tube has an inside diameter of 30" (762mm).

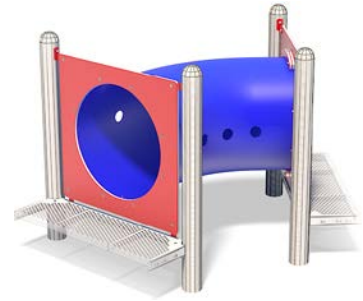

### 45° Crawl Tunnel

Connects two decks at the same height at a 45° angle.

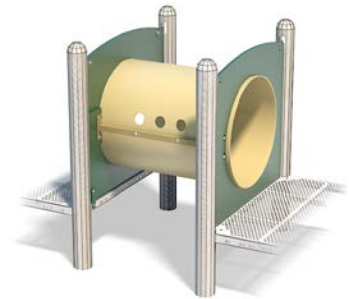

### 3ft Crawl Tunnel

Connects two decks at same height. Available in lengths 3ft to 6ft.



### Playfort Crawl Tunnel

Connects two decks at same height. Available in lengths 3ft to 6ft.



### 6ft Crawl Tunnel

Connects two decks at same height.

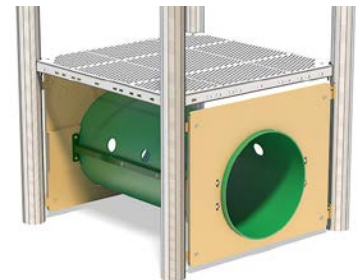

### Underpass Crawl Tunnel

A crawl tunnel designed to use space underneath a playground deck.

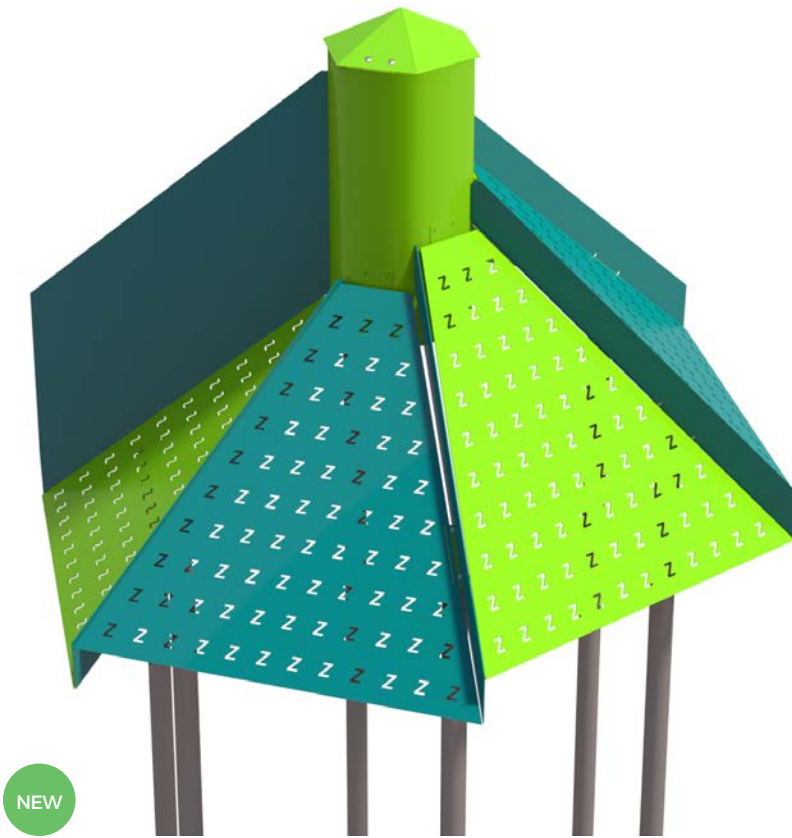

NEW

### Staggered Hex Roof

An innovative new hex roof style that looks different from different angles. Panels or infills (solid) can be different colors to create styles.

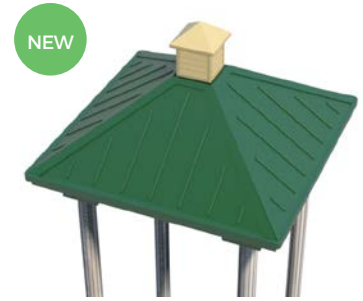

NEW

### Cupola Roof

A peaked roof design with a cupola on top.

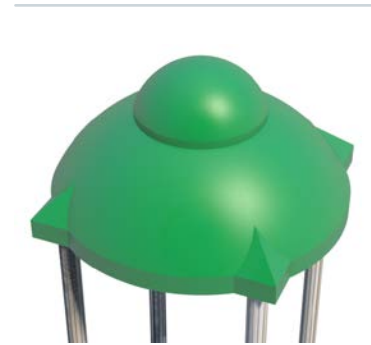

### Dome Roof

A fanciful roto-molded plastic roof.



### Double Arch Roof

Perforated steel roof with durable powder-coat paint finish used over two square decks.



### Bowed Roof

Perforated steel roof with durable powder-coat paint finish. For a square deck



### Really Big Barn Roof

A solid, barn-themed HDPE roof. For four square decks.





### Gable Roof

A roto-molded plastic roof with plenty of architectural interest.

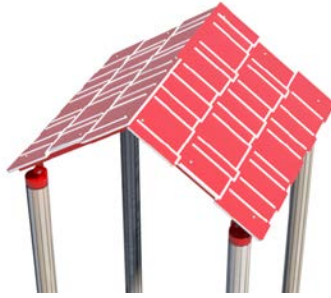

### Plastic Peaked Roof

A solid HDPE roof with shingle detailing. Double Peaked Roof also available.

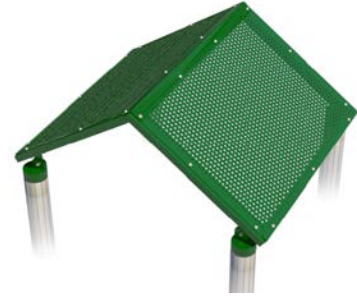

### Steel Peaked Roof

Perforated steel roof with durable powder-coat paint finish.

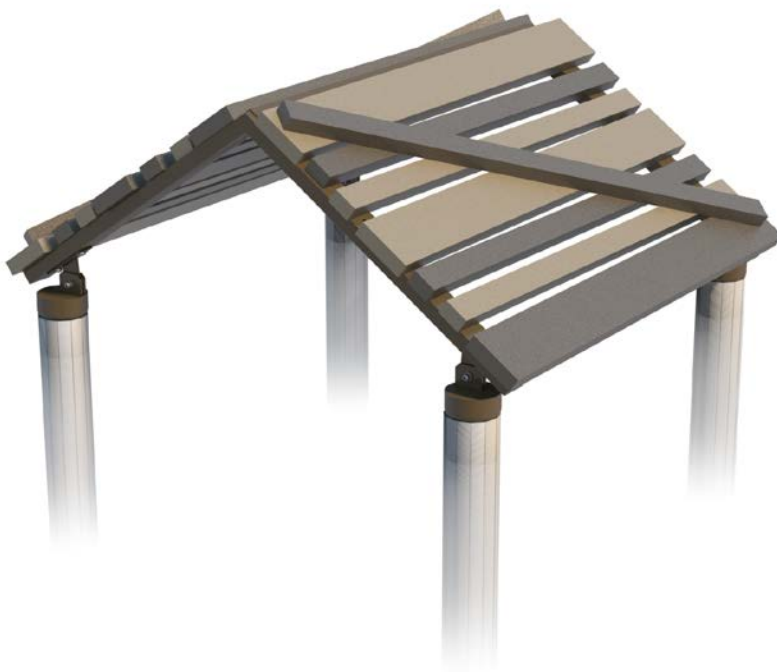

### Playfort Roof

Our new Playfort roof is really popular with kids. It may look like a bunch of kids built it but this one is really durable and is meant to last with a steel frame and recycled plastic boards.



### The Big Roof

An extra-large roto-molded plastic roof with attractive shingle detailing. For a hex deck.



### Steel Hex Roof

Perforated steel roof with durable powder-coat paint finish. For a hex deck.



### Plastic Hex Roof

A solid, hex designed HDPE roof. For hex shaped decks.



### Leaf Roof

A nature themed HDPE play roof, offering partial shade.



NEW

### HALO ROOF

The Halo roof adds a new modern design look to any playground.



### Steel Octagon Roof

Perforated steel roof with durable powder-coat paint finish. Designed to fit over an octagon hex deck.



NEW

### Pine Tree Post Topper

Add a few pine tree post toppers to your nature inspired playground to enhance the natural look.



### Pyramid Roof

An attractive roto-molded plastic roof.



NEW

### Mushroom Roof

A fanciful HDPE roof. Requires only one full-length post.



NEW

### Arch Post Topper

Add a little flare to the tops of the posts to create a new look.



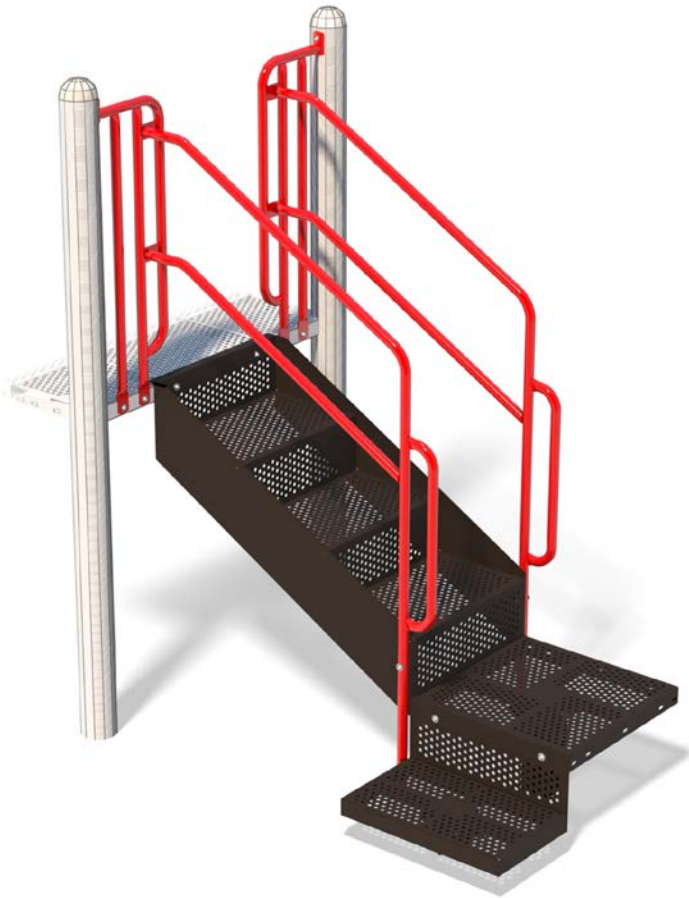

### Transfer Station

Short steps help kids get from a wheelchair to the play area.  
Deck Heights- 2,3,4,5ft (0.6,0.9,1.2,1.5m)



### Accessible Step-up

A special needs access point for children and caregivers.  
Available in 12', 24', 32' and 48" sizes.



### Senior Stepladder

Non-skid plastic steps with side rails for stability.  
Deck Heights- 3,4,5,6,7ft (0.9,1.2,1.5,1.8,2.1m)

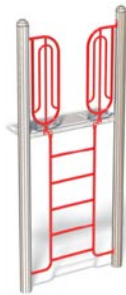

### Deck Ladder

For use at ground level or between decks.  
Deck Heights- 3,4,5,6ft (0.9,1.2,1.5,1.8m)



### Stairs

An easy access for children and caregivers. Deck Heights- 3,4,5ft (0.9,1.2,1.5m)

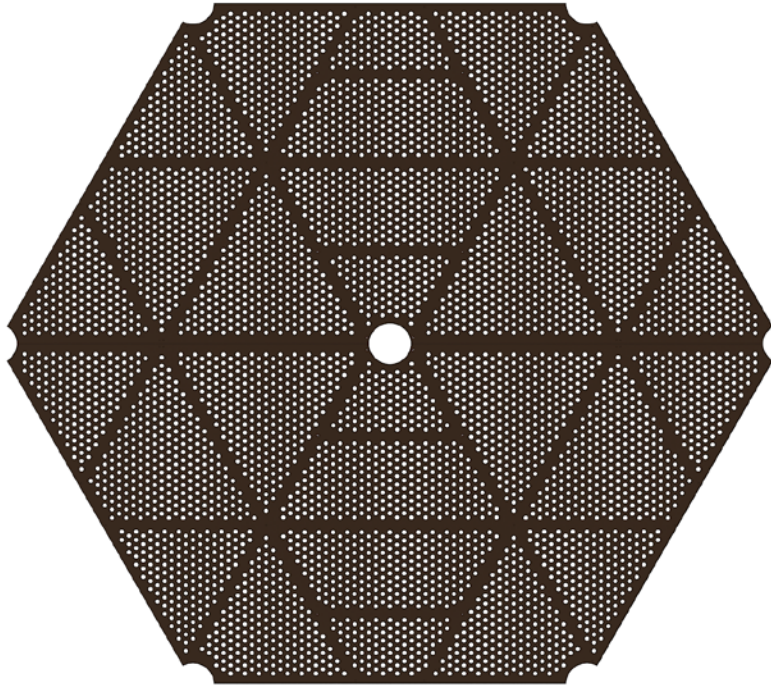

### Hex Deck

PlaySteel Max  
PlaySteel Fit

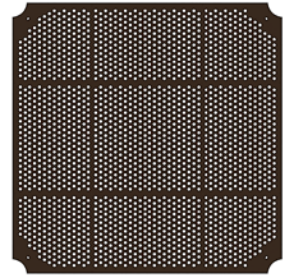

### Square Deck

PlaySteel Max  
PlaySteel Fit

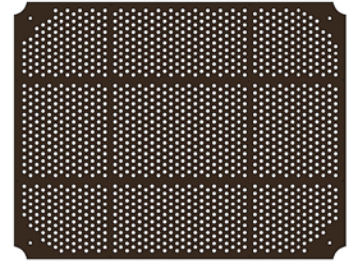

### Rectangle Deck

PlaySteel Fit

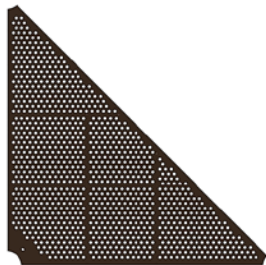

### Split Deck

PlaySteel Max  
PlaySteel Fit

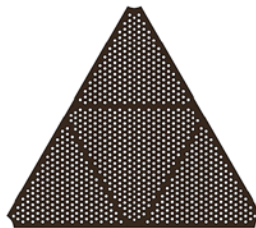

### Triangle Deck

PlaySteel Max  
PlaySteel Fit

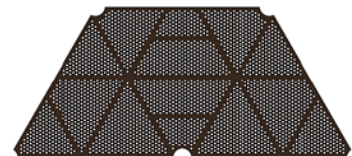

### Half Hex Deck

PlaySteel Max  
PlaySteel Fit



NEW



### Playfort Window Panel

Kid inspired Playfort window panel has a Plexiglas window and sign "Kids Only," Looks great and is fun for children to peer out over the playground.



### Playfort Magnifying Panel

Using the hand hole you can reach through to see objects in the center magnifying glass. What a great opportunity to teach children to look closely at ordinary or extraordinary things.



### Playfort Bench

Tired of running around, need to take a break and chat with friends, well the Playfort bench is the perfect spot to chill out. Place under a deck or use freestanding.



### Playfort Rail Panel

Playfort panel with "kid inspired" design. Even has holes in the wood for kids to peek through.



### Playfort Entrance

A fort-inspired add-on for any playground. For use at roof height.



### Woodgrain Porthole Panel

A fun ground level crawl through panel used on ship themed playgrounds.



### Woodgrain Playcounter

A play counter for creative and cooperative play. For use under a deck or freestanding.



### Castle Arch Panel

A child-sized doorway. For ground level use. Double-sided.



### Woodgrain Window Panel

Window panel with woodgrain look for those nature inspired playground designs.



### Castle Wall Panel

A castle-inspired barrier panel. Double-sided.



### Castle Window Panel

A castle-inspired barrier panel. Details are engraved, not cut through. Double-sided.



### Castle Battlement

A castle-inspired add-on. Great alone or in multiples around a deck. For use at roof height.



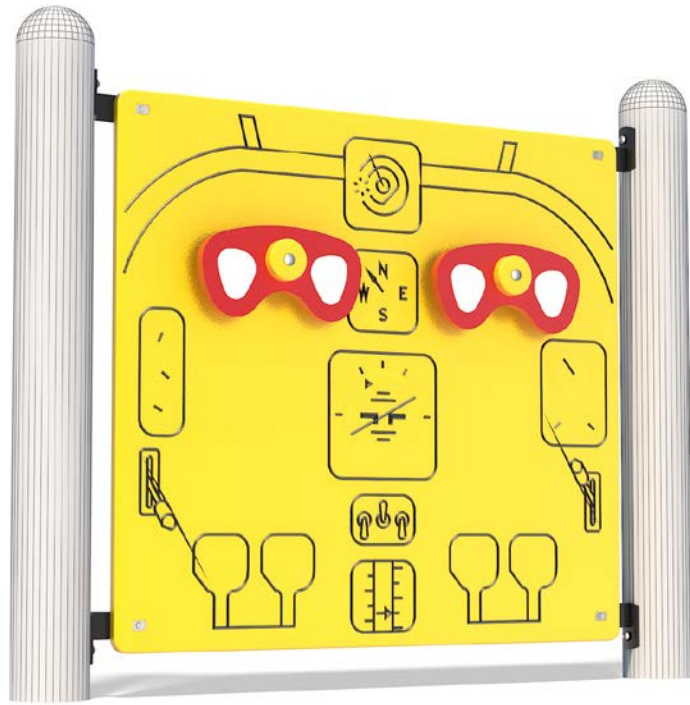

NEW

### Airplane Panel

With controls for pilot and co-pilot. Double-sided with an airplane image on reverse.



### Dino Panel

With friendly, spinning dinosaurs. Perfect for an X & O style game.

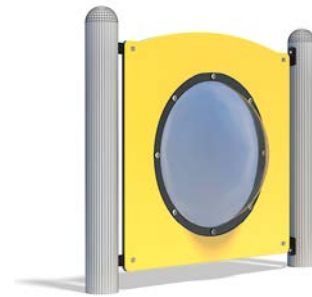

### Bubble Panel

A preschool favorite. Durable, polycarbonate bubble serves as a silly window.

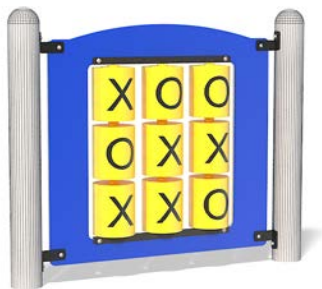

### X & O Panel

A classic game, on or off the playground. Accessible from front and back.



### Sign Language Panel

Learning to sign has never been easier. Double-sided with "Stop and play" message on reverse.



### Play Bench Panel

A small seat and window makes a tranquil spot where children can rest or socialize.

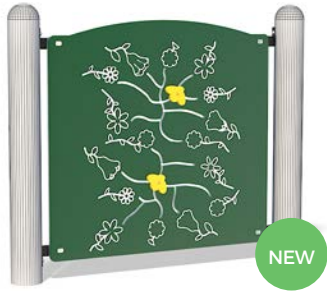

### Honey Bee Panel

Help the bees collect their honey in this interactive and manipulative panel.



### Sign Language Braille Panel

Learning to sign and use Braille has never been easier. Double-sided with "stop and play" message on reverse.



### Garden Fairy Game

A playground game for two players. Children spin the dial then move their markers. The first player to 10 wins the game.



### Cow Barn Panel

A cow barn theme panel to go with barn roof theme.

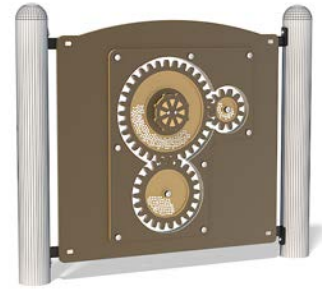

### Turn And Tumble Panel

Watch and listen as the white balls tumble with rain drop noise when the gears are turned.



### Magnifying Panel

Using the hand holes you can reach through to see objects in the center magnifying glass. What a great opportunity to teach children to look closely at ordinary or extraordinary things.





### Playtable

A small table where kids can manipulate toys, play with sand or read a book.



### Atlantic Map Panel

An educational map of Atlantic Canada.



### Musical Chime Panel

Chimes allow children to make their own music. Double-sided.



### Canada Map Panel

An educational activity, great for playing school. Includes all provinces and territories with abbreviations.



### USA Map Panel

Includes all state names and abbreviations. Double-sided with Hawaii and Alaska on reverse.



### Western Canada Map Panel

An educational map of Western Canada.



### Fire Engine Panel

Pretend to put out the fire with this imagination panel.



### Ontario Map Panel

An educational map of Ontario.



### Playstore Panel

Double-sided with cash register graphic on reverse. For ground level use.

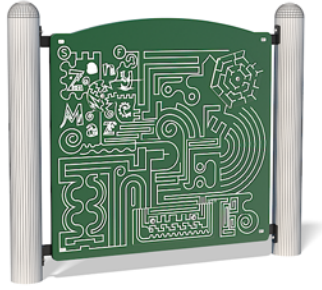

### Zany Maze

A finger maze with three moving parts. Double-sided with "Zany Maze" on reverse.

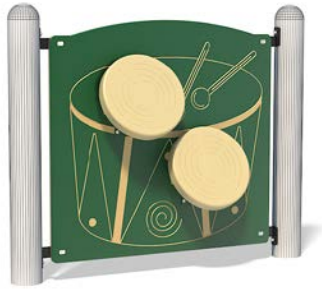

### Drum Panel

Two plastic drums let children make their own music.

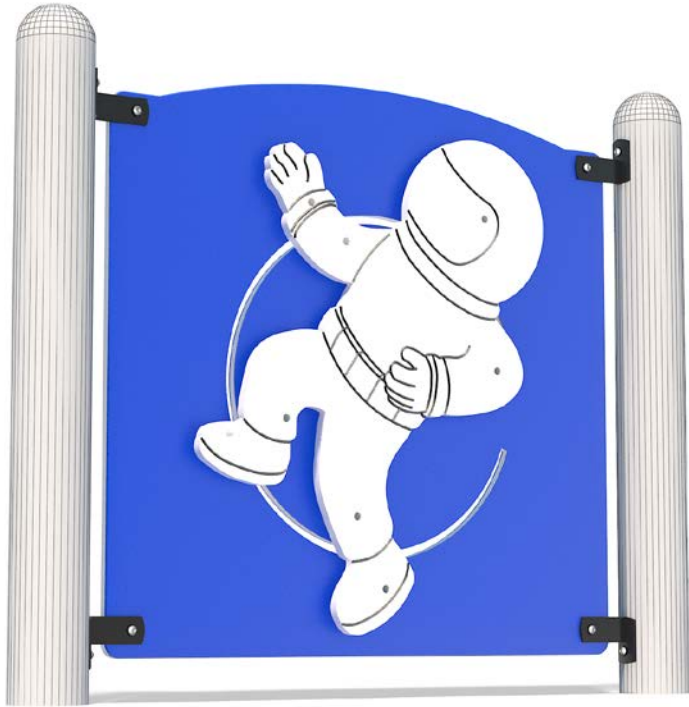

### Solar System Panel

Help the astronaut discover the solar system in this interactive and manipulative panel.



### Hippo Crawl Thru

A fun imaginative crawl-through panel and the only safe way to play with a hippo.



### Happy Landings Panel

Children can guide the rocket and hot air balloons to a safe landing in the manipulative panel.

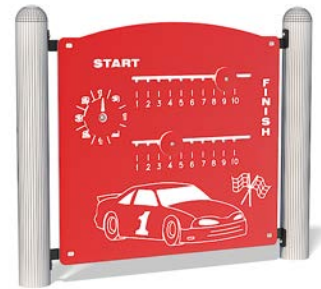

### Racecar Game

A playground game for two players. Children spin the dial then move their markers. The first player to reach 10 wins the race.



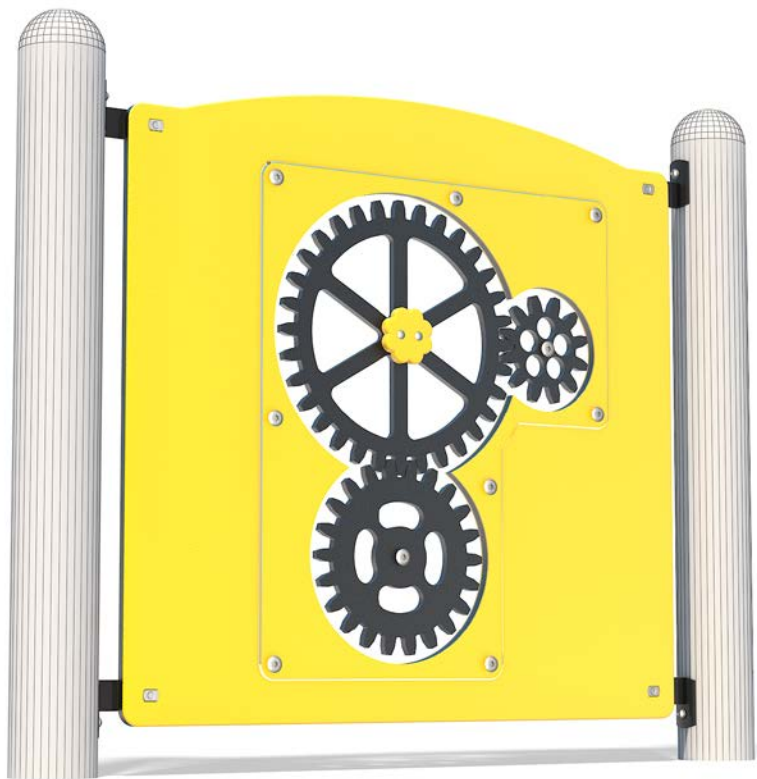

### Gear Panel

Features three moving gears. Makes mechanics fun for children.



### Alphabet Panel

Perfect for tracing letters or playing school. Double-sided with playful designs on reverse.

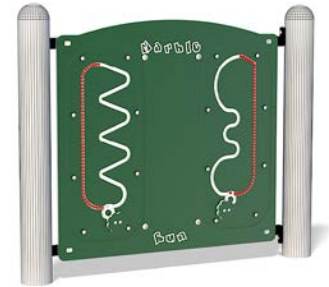

### Marble Run Panel

A fun playground game for up to three players- two on the front, one in the back. Children race to see whose marble finishes the track first.

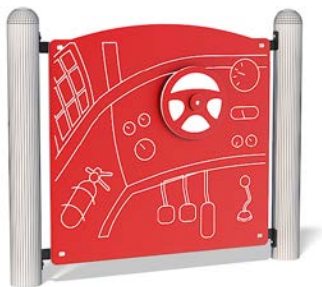

### Racecar Panel

With a realistic console and steering wheel. Double-sided with a race car on the reverse.



### Finger Maze Panel

Trace your way from the start to end with this challenging finder maze puzzle.



### Custom Panel

Need a school logo or a panel thanking those that have donated funds for your local playground? This is the panel you need. Just provide us with a vector base image such as an Adobe Illustrator file and we can cut your graphic into the panel!

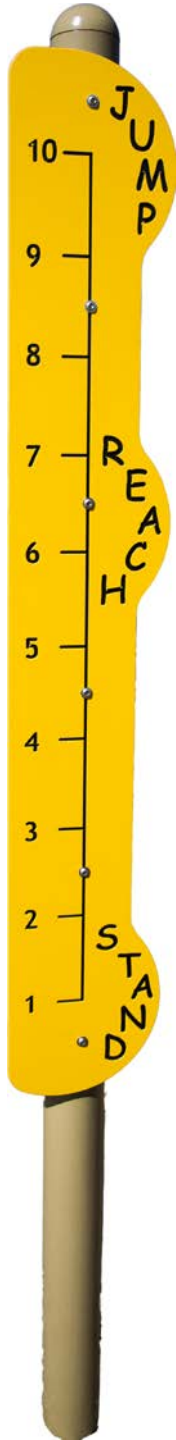

### Jump Panel

Children compete in a friendly game to see how high they can jump and reach.

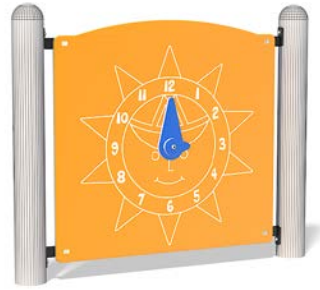

### Clock Panel

Friendly clock features two moving hands. Great for learning to tell time or playing school.



### Puppet Theatre

Compact theatre is a perfect showcase for the imagination.



### Gadget Panel

Great for fine motor skills and cooperative play. Multiple activities in one panel.





### Ship's Rail Panel

A whimsical touch. Perfect for playships or verandas. Double-sided.



### Porthole Panel

With a circular opening. For ground level use. Double-sided.



### Window Panel

Equally well-suited for playhouses and playships. Double-sided with spooky cabin scene on reverse.

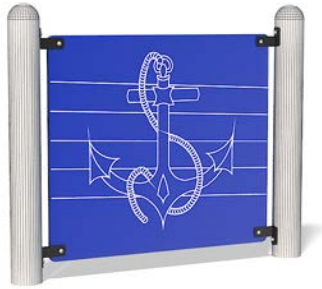

### Anchor Panel

Adds nautical flair to any playground. Double-sided with bird and anchor scene on reverse.



### Playhouse Panel

Turns a playground into a playhouse. For ground level use.



### Balance Ball Game

A steering wheel with a challenging marble game inside. Balance all three balls and win. Attaches to any post.



### Mirror Gaze Add-On

Fun little mirrors so kids can make goofy faces.



### Game Panel Add-On

A playground game for two players. Children spin the dial then move their markers. The first player to 5 wins the game. Attaches to any post.

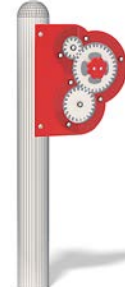

### Gear Panel Add-On

Makes mechanics fun for children with three spinning gears. Attaches to any post.

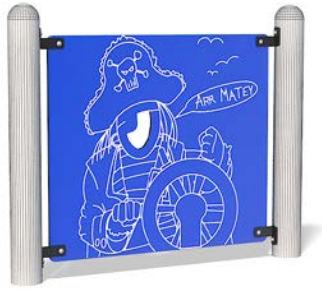

### Pirate Face Panel

Arr Matey! Let's set sail across the seven seas. This is the perfect panel for memorable photos with the kids.



### Bean Bag Toss Panel

Bring some bean bags or small balls to turn this panel into a fun and challenging game.



### Mirror Panel

An early childhood favorite. Unbreakable polished stainless steel mirror with side slots for ease of supervision.



### Steel Seat Under Deck Panel

Steel seat panel under deck provide an area to rest and chat.



### Steel Countertop

A steel play counter. For use under a deck. Also available freestanding.



### Window Panel with Seat

Includes a small bench and porthole-style window. Constructed entirely of steel. For use at ground level or with a playhouse roof.

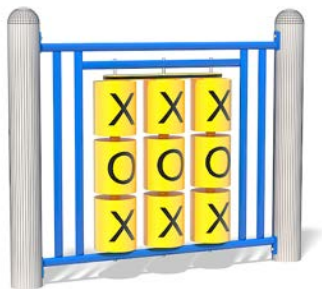

### Steel X & O Panel

A classic game, on or off the playground. Constructed on a steel frame.

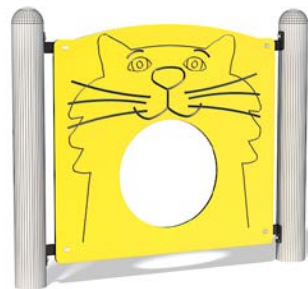

### Kitty Crawl Thru

A fun imaginative crawl-through panel.

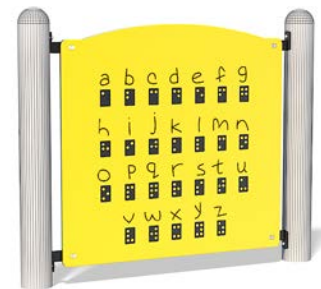

### Braille Panel

Children learn the Braille alphabet, then use their skills to decode a message. Double-sided with a secret message on reverse



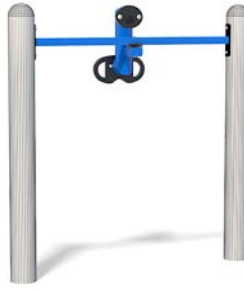

### Periscope

Wheelchair-accessible periscope or ground level access panel.



### Word Tumbler

Children practice spelling three-letter words with independently-spinning alphabet discs. Double-sided. Wheelchair-accessible at ground.



### Mini Clock Panel

A smaller version of our clock panel, complete with moving hands and an adjustable digital-style clock.



### Mini Racecar Panel

Wheelchair-accessible at ground level. Double-sided with racing vehicle on reverse.



### Xylophone Panel

Children can make their own music at play. Wheelchair accessible at ground level.



### Treasure Hunt

A non-competitive playground game. Young children spin the side-by-side cylinders to uncover the buried treasures within. Double-sided. Wheelchair-accessible at ground level.



### Mini Chalkboard

An accessible and mini version of our full size chalk panel.



### Mini Push Panel

Push the truck over the hilly terrain or race the boat across the water on this interactive panel.



### Mini Airplane Panel

Includes two sets of controls for friendly co-pilots. Wheelchair-accessible at ground level.



### Mini Math Panel

With ten sliding beads and five spinning dials to work out simple math problems. Wheelchair-accessible at ground level.



### Mini Helm Panel

Steering wheel makes a great addition to playships and nautical themes.



### Maze Wheel Mini Panel

Steering wheel doubles as a challenging marble maze.



### Talk Tube (Deck Mounted)

A set of two functional speaking cones connected by underground tubing.



### Steering Wheel Panel

Turn a classic barrier panel into an early childhood favorite with the simple addition of a steering wheel.



### Balance Ball Panel

A steering wheel with a challenging marble game inside. Balance all three balls and win.



### Maze Wheel Panel

Turns a classic barrier panel into an all-ages activity. Steering wheel doubles as a challenging marble maze.



### PlayShip's Helm Panel

A nautical steering wheel turns a classic barrier panel into an early childhood favorite. Perfect for playships!



### Vertical Rail Panel

A classic steel barrier panel. Open design makes supervision simple.





### Balcony Table

Includes two pod seats and a table. A comfortable place for rest or play.



### Talktubes

A set of two functional speaking cones connected by underground tubing. Available freestanding at ground level (shown) or deck-mounted.

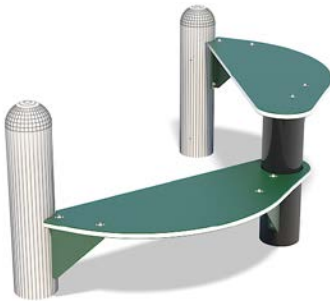

### Bi-Level Play Counter

A two-tier counter accommodates more children. For use freestanding or under a deck.

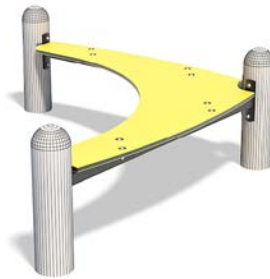

### Corner Bench

A comfortable spot for a break or a visit. For use under a square deck.

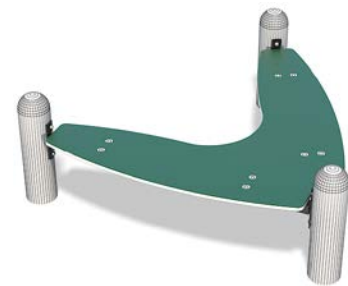

### Boomerang Bench

A comfortable resting place for multiple children. For use under a triangle deck

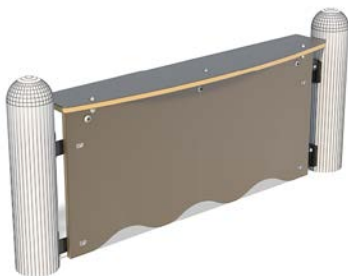

### Playcounter

A play counter for creative and cooperative play. For use under a deck or freestanding.

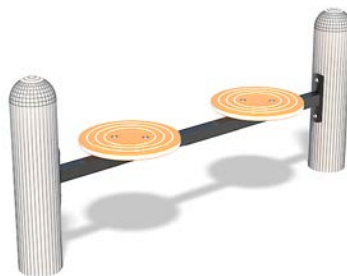

### Double Pod Seat

Twin seats make a perfect resting place for two. For use under a deck or freestanding.

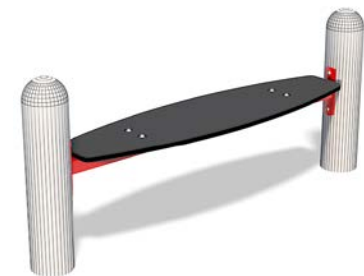

### Play Seat

A textured playseat that can be used as a bench or table.



### Round Piano Panel

Play a tune and learn music on this interactive musical touch sensitive Piano panel. Touching the stainless metal pads produces a musical note. Battery operated. Easy to maintain.



### Playship Bow

Great for nautically themed play, and essential for all playships.



### Round Buzz Panel

The colors and shapes reaction game it is easy to follow, easy to play and great fun.



### Round Drum Panel

Drum out a musical note on this drum panel. A great addition to any support posts for ground level activities.



### Round Maze Wheel Panel

Weave the stainless metal ball through the maze wheel. A fun and difficult maze challenge.



### Playship Helm

A sturdy, HDPE ship steering wheel. Attach this popular activity to any post.



### Steering Wheel

This popular activity can be attached to any post. An early childhood favorite.



### Driving Station

A freestanding racecar driving event that works great in areas with little room.







Out of this world Orbital fun!







# Orbital Fun for Kids

Striking and modern in design, kids and grown-ups can't resist the Orbis—the play system that puts the focus on physical activity. Free from entrances and exits, Orbis lets children interact without boundaries with the play events around them.



## Ultimate Play Time

The orbital ring is the key to the Orbis. All the climbers and arches and overhead play elements extend out from the spherical ring. Kids love the innovative design of Orbis often choosing it over traditional playgrounds to play on. You can't go wrong—each one is a proven winner with children.

## Space Built Quality

Through the power of the Antigravity Clamp, play components in Orbis's orbit are frozen in space, defying Newton's law of gravity. Cast from aluminum, the Antigravity Clamp is engineered and tested to endure all that the universe offers. All of the Orbis clamps are oversized for added strength and durability.

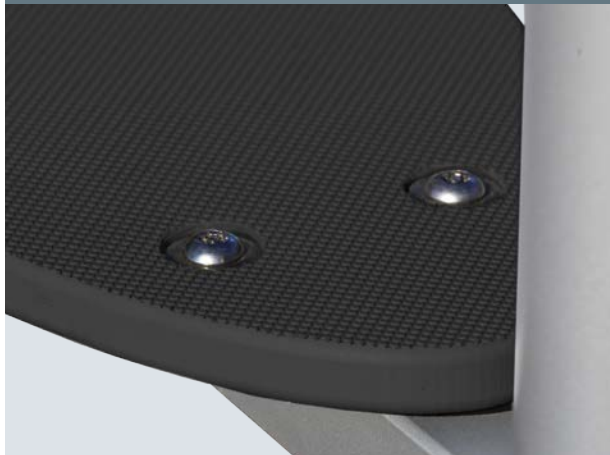
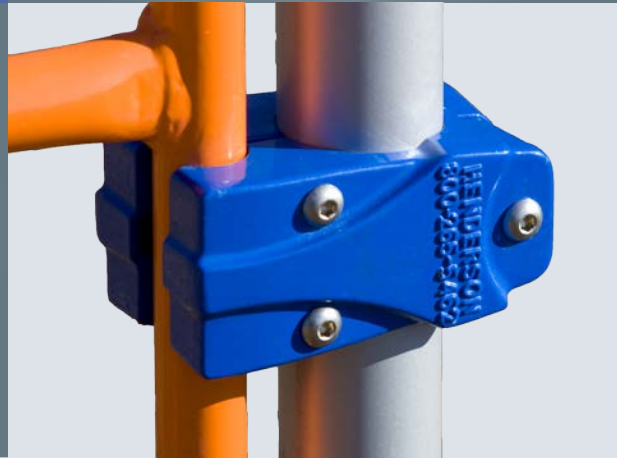

## Terra Traction

Kids access the heights of Orbis with a stepping pad or launch pad constructed from Terra Traction—a durable, non-skid polyethylene. We use this non-skid polyethylene for added traction and safety.



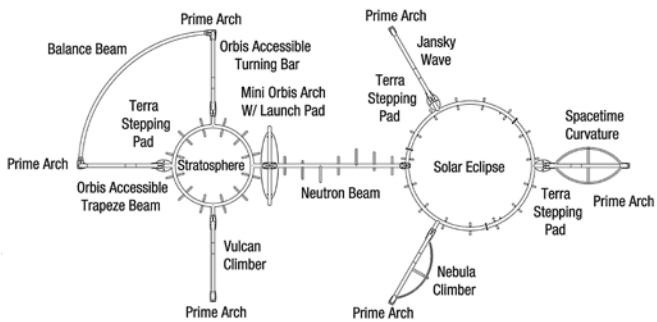





### Model #OB00175

Age:	5 to 12	ASTM F1487:	✓
Play Events:	14	CAN/CSA-Z614:	✓
Use Zone:	45' x 29' (13.7 x 8.8m)	CPSC Pub.325:	✓
ADA:	✓		



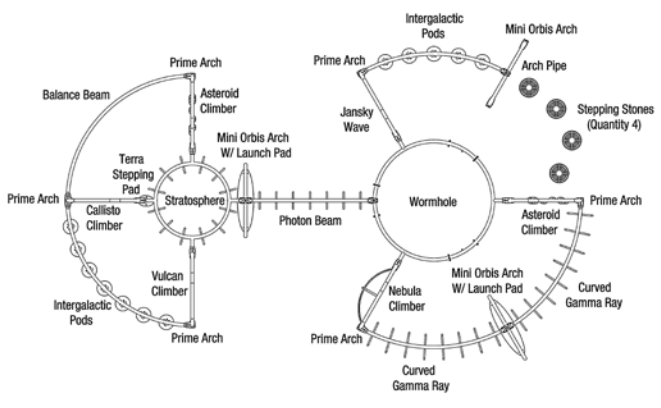





### Model #OB00225R3

Age:	5 to 12	ASTM F1487:	✓
Play Events:	18	CAN/CSA-Z614:	✓
Use Zone:	46' x 33' (14.0 x 10.0m)	CPSC Pub.325:	✓
ADA:	✓		



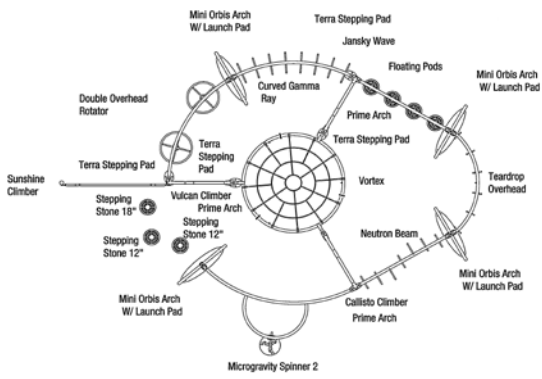

## Model #OB00319

Age:	5 to 12	ASTM F1487:	✓
Play Events:	24	CAN/CSA-Z614:	✓
Use Zone:	44' x 36' (13.4 x 11.0m)	CPSC Pub.325:	✓
ADA:	✓		









## Model #OB00393

Age:	5 to 12	ASTM F1487:	✓
Play Events:	24	CAN/CSA-Z614:	✓
Use Zone:	37' x 34' (11.3 x 10.4m)	CPSC Pub.325:	✓
ADA:	✓		



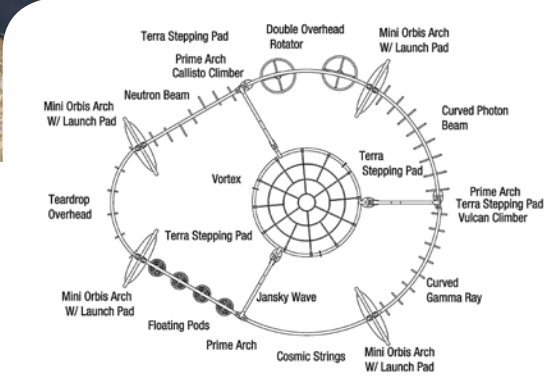





## Model #OB00392

Age: 5 to 12  
 Play Events: 12  
 Use Zone: 32' Dia. (9.8m)  
 ADA: ✓  
 ASTM F1487: ✓  
 CAN/CSA-Z614: ✓  
 CPSC Pub.325: ✓

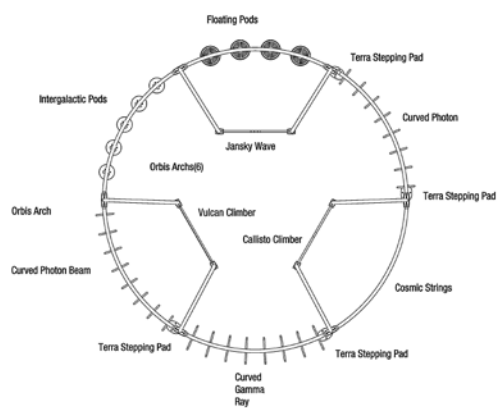

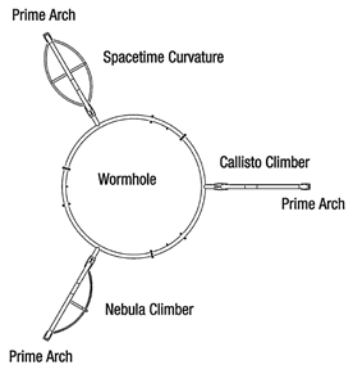

### Model #OB00376

Age:	5 to 12	ASTM F1487:	✓
Play Events:	20	CAN/CSA-Z614:	✓
Use Zone:	29' x 27' (8.8 x 8.2m)	CPSC Pub.325:	✓
ADA:	✓		

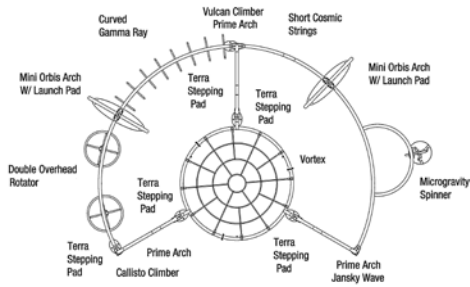

### Model #OB00375

Age:	5 to 12	ASTM F1487:	✓
Play Events:	12	CAN/CSA-Z614:	✓
Use Zone:	36' x 28' (11.0 x 8.5m)	CPSC Pub.325:	✓
ADA:	✓		



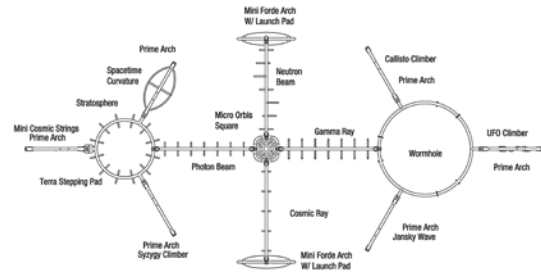

**Model #OB00377**

Age:	5 to 12	ASTM F1487:	✓
Play Events:	16	CAN/CSA-Z614:	✓
Use Zone:	54' x 32' (16.5 x 9.7m)	CPSC Pub.325:	✓
ADA:	✓		

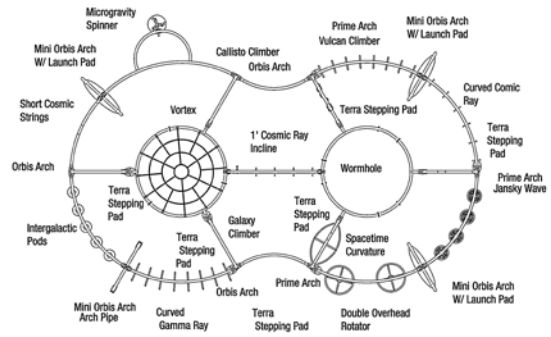

**Model #OB00379**

Age:	5 to 12	ASTM F1487:	✓
Play Events:	24	CAN/CSA-Z614:	✓
Use Zone:	48' x 38' (14.6 x 11.6m)	CPSC Pub.325:	✓
ADA:	✓		

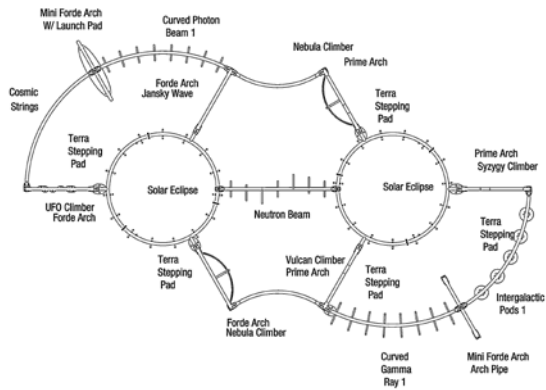

### Model #OB00388

Age:	5 to 12	ASTM F1487:	✓
Play Events:	20	CAN/CSA-Z614:	✓
Use Zone:	47' x 32' (14.3 x 9.8m)	CPSC Pub.325:	✓
ADA:	✓		

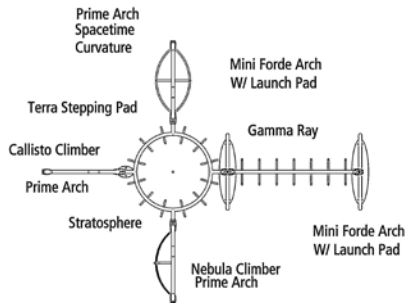

### Model #OB00382

Age:	5 to 12	ASTM F1487:	✓
Play Events:	12	CAN/CSA-Z614:	✓
Use Zone:	33' x 29' (10.0 x 8.8m)	CPSC Pub.325:	✓
ADA:	✓		



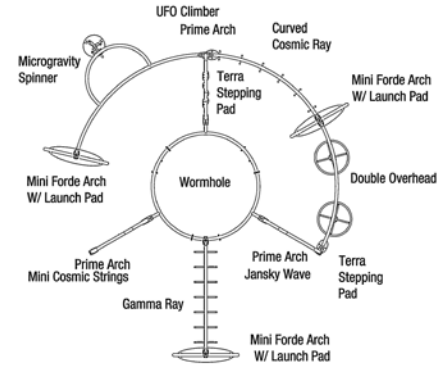

**Model #OB00383**

Age:	5 to 12	ASTM F1487:	✓
Play Events:	12	CAN/CSA-Z614:	✓
Use Zone:	35' x 34' (10.7 x 10.4m)	CPSC Pub.325:	✓
ADA:	✓		

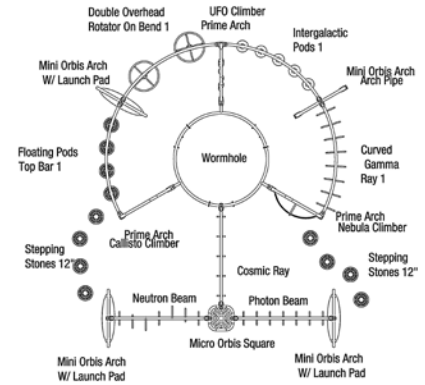

**Model #OB00385**

Age:	5 to 12	ASTM F1487:	✓
Play Events:	17	CAN/CSA-Z614:	✓
Use Zone:	37' x 36' (11.3 x 11.0m)	CPSC Pub.325:	✓
ADA:	✓		

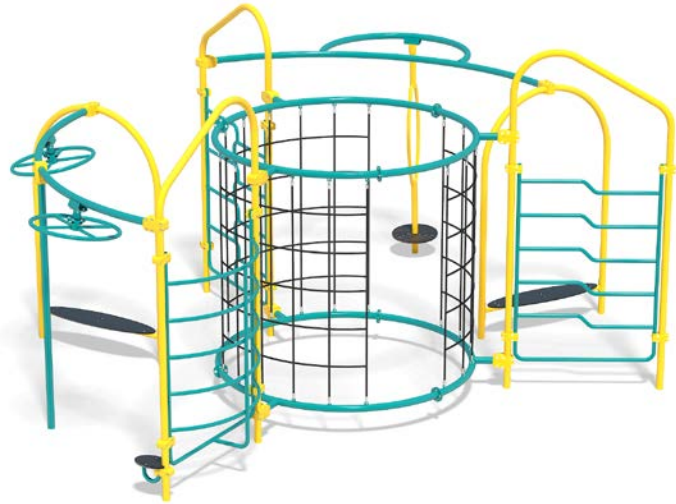
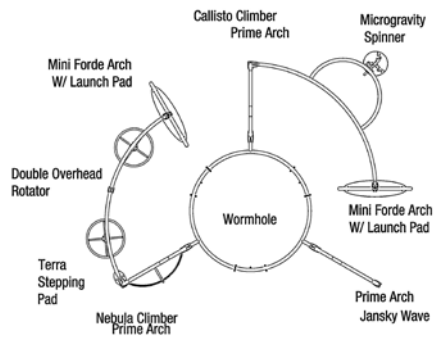

### Model #OB00384

Age: 5 to 12  
 Play Events: 12  
 Use Zone: 33' x 27' (10.0 x 8.2m)  
 ADA: ✓

ASTM F1487: ✓  
 CAN/CSA-Z614: ✓  
 CPSC Pub.325: ✓

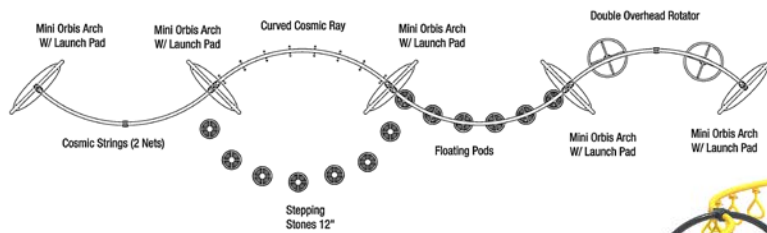

### Model #OB00387

Age: 5 to 12  
 Play Events: 12  
 Use Zone: 61' x 22' (18.6 x 6.7m)  
 ADA: ✓

ASTM F1487: ✓  
 CAN/CSA-Z614: ✓  
 CPSC Pub.325: ✓





# Orbis Play Components

Kids love the freedom of Orbis often choosing it over traditional playgrounds to play on. You can't go wrong—each one is a proven winner with children. Choose from the many climbing, spinning, and overhead play event the Orbis line has to offer.



## Round and Round we go.

The overhead rotator has been tested for over a million cycles with 930 lbs (442 Kg) . Its superior bearing will meet the demands of children for years.

This is one our most popular play events of all time. The overhead rotator is a definite kid pleaser!

## Overheads that Soar

The orbital ring is the key to the Orbis. All the climbers, arches, and overhead play elements extend out from the spherical ring.

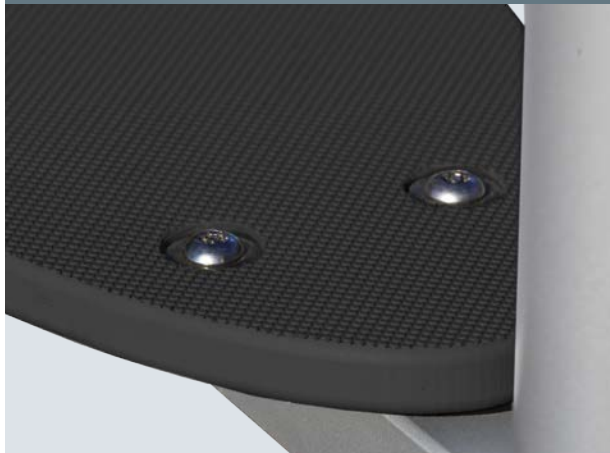

## Terra Traction

Kids access the heights of Orbis with a stepping pad or launch pad constructed from Terra Traction—a durable, non-skid polyethylene. We use this non-skid polyethylene for added traction and safety.





### Intergalactic Pods Large

This curved climber is always a popular activity for multiple children. Steel rails feature staggered non-skid plastic pods. Open sight lines are maintained for ease of supervision.



### Intergalactic Pods Medium

The medium size intergalactic Pod Climber that provides a fun challenging rope play event.



### Intergalactic Pods Small

The smallest version of the intergalactic Pods, the perfect climbing challenge for small spaces.



### Cosmic Strings Bar 4

Two sets of Cosmic Strings on a long Bar 4 curvature. This curved cable climbing wall challenges children to climb up and over. Maintains open sight lines for ease of supervision.



### Cosmic Strings

This curved cable climbing wall challenges children to climb up and over. Maintains open sight lines for ease of supervision.

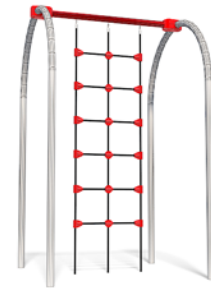

### Mini Cosmic Strings

This compact cable climbing wall challenges children while keeping climbing confidence high. Maintains open sight lines for ease of supervision.



### Micro Cosmic Strings

This compact cable climbing wall challenges children while keeping climbing confidence high. Maintains open sight lines for ease of supervision.



### Vulcan Climber

Side-by-side vertical ladders encourage cooperation at play. This activity maintains open sight lines for ease of supervision.



### Space-time Curvature

An impressive series of irregularly curved rungs distinguishes this from our other side-by-side ladders.



### Callisto Climber

Side-by-side staggered climbing ladders are a winning combination for cooperative playground fun. Maintains open sight lines for ease of supervision.



### Jansky Wave Climber

Playground supervision is made simple with this fun variation on the vertical ladder. Open sight lines are easily maintained.



### Nebula Climber

Children are challenged to go higher with this vertical ladder-style climber with curved rungs. Open sight lines are maintained for ease of supervision.



NEW

### Hourglass Climber

A challenging vertical climbing event with moving components. A great way for children to develop their climbing skills in a fun way.



### Mini Jansky Wave

A twist on the vertical ladder, this product makes supervision a breeze with open sight lines. A compact climber in comparison to other Orbis climbers.



NEW

### Mini Planet Climber

Climb the planets to extend into the far reaches of space. The Mini Planet Climber provides a compact low level but fun climbing experience.





### Meridian Tear-drop Overhead

A curved overhead activity with the added challenge of swinging, triangular rungs.



### Zodiac Overhead

Fixed loops on a compact curved beam give children the confidence to move from beginner brachiation to mastery.



### Double Overhead Rotator

For added fun and excitement, our infinitely popular overhead rotator is now available as a pair. Henderson's specially-engineered bearing meets (and exceeds) our strict quality control standards.



### Vortex

So many opportunities for exploration and learning are possible with this open-ended play activity. A tensioned cable net forms the framework for play. Features three connection nodes for the attachment of arches and play components.



### Meridian Overhead

A small but challenging trapeze style overhead.



### Balance Beam Bar 4

The longest, most challenging balance beam in the Orbis line.



### Cosmic Ray

A straight overhead activity with the added challenge of swinging, triangular rungs.



### Neutron Beam

Round loops are creatively placed on this beam, giving it a playful look and a challenging overhead play experience.



### Photon Beam

The round loops on this straight overhead give children a perfect practice space for developing skills.

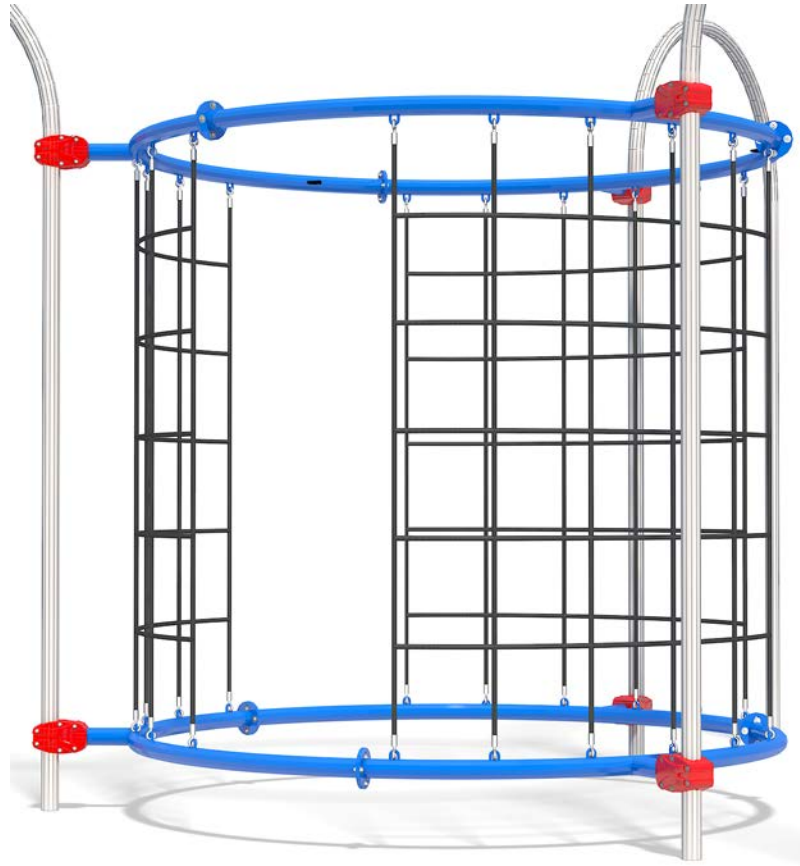

### Wormhole

With so many options for use, it's no wonder children love this flexible cable climbing cylinder. Features three connection nodes for the attachment of arches and play components. Maintains open sight lines for ease of supervision.



### Gamma Ray

A great component that gives children a sense of achievement as they perfect their brachiating skill on these large triangular rungs.



### Tear-drop Overhead

This swinging trapeze overhead provides a fun challenge greater than the traditional overhead ladders.





### Curved Photon Beam

A longer and more challenging version of the Photon Beam overhead.



### Curved Gamma Ray

This long, curved overhead activity gives children a sense of accomplishment as they perfect their brachiating skill using large triangular rungs.



### Curved Cosmic Ray

A shorter, and less taxing version of the Cosmic Ray overhead.



### Quasar Overhead

Children gain confidence as they traverse this compact curved beam of fixed triangular rungs.



### Small Triangulates

A smaller version of the Triangulates



### Stratosphere

Eye-catching oversized rings keep children challenged as they explore overhead play. Loops are fixed in place on a mid-sized circular overhead beam. Available with three or four connection nodes.



### Solar Eclipse

This extra-large overhead play circuit gives children ample opportunity to practice the skill of brachiation with the added challenge of swinging, triangular grips. Features three connection nodes for design versatility.



### Floating Pods Top Bar 4

The largest most challenging Floating Pods. Great for improving balance and other motor skills.



### Terra Stepping Pad

Non-skid HDPE stepping pads connect to Orbis posts to add functionality and accessibility to overhead play elements. Children also enjoy these as play seats.



### Launch Pad

The non-skid HDPE launch pad rests between an Orbis arch and adds functionality to your overhead play elements. The launch pad is also a popular bench when children are ready to take a break.



### Microgravity Spinner

An updated design of the undoubtedly most popular Orbis component that is available. Kids positively love this spinner and it keeps them coming back time over time.



### Hourglass Spinner

An updated design of one of the most popular playground components. Kids absolutely love the Hourglass Spinner. Kids often work together and take turns to spin each other.



### Accessible Paddle Power

Children of all abilities enjoy this suspended paddle wheel, which also provides vigorous upper body exercise. This activity easily connects with the larger Orbis structure for integrated play.



### Accessible Trapeze Bar

This wheelchair accessible upper body provide extra upper body challenge that can be easily accessed in a wheelchair.



### Accessible Turning Bar

This wheelchair accessible upper body activity easily connects with the larger Orbis structure for integrated play.







# Tot Size Fun!

PlayTots is a great mix of durability and value, and is perfect for today's smaller facilities. Its components are developmentally appropriate, and are sized just right for the smaller height, reach, and step of pre-schoolers. PlayTots attractive designs are inviting to children as well as caregivers, and encourage learning.



## New Redesigned Components

PlayTots has been scaled to Tot size proportions make it even better for the little ones to play and have fun. Non-skid ramp-like climbers help children climb or crawl onto the decks.

## Curvy Panels & Textured Decks

These curvy entrance panels are more eye catching than our previous straight linear panels. We even added more hand grip locations to accommodate children with different reaches and heights.

Decks are textured for added grip giving children a better footing.



## Fun Panels

Depending on model, panels can feature mirrors, peek-a-boo spots, and magnifying glasses to help children learn about things they discover around the playground like bugs and rocks.



NEW

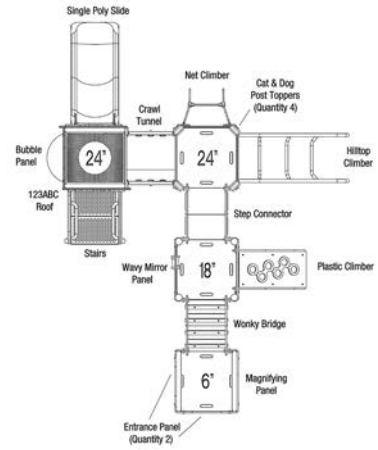

## PLAYTOTS #1

Age: 2 to 5 (1.5 to 5 CAN)  
 Play Events: 17  
 Use Zone: 29' x 26' (8.8 x 7.9m)

ASTM F1487: ✓  
 CAN/CSA-Z614: ✓  
 CPSC Pub.325: ✓

NEW

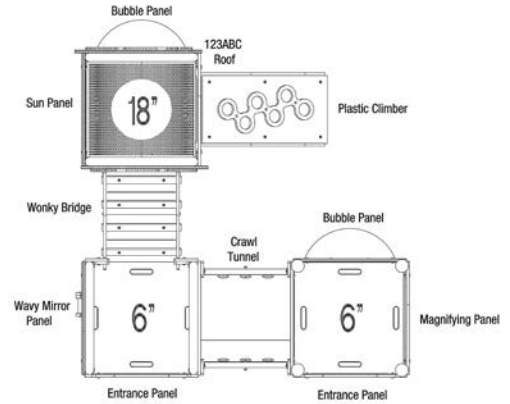

## PLAYTOTS #2

Age: 2 to 5 (1.5 to 5 CAN)  
 Play Events: 11  
 Use Zone: 21' x 20' (6.4 x 6.1m)

ASTM F1487: ✓  
 CAN/CSA-Z614: ✓  
 CPSC Pub.325: ✓

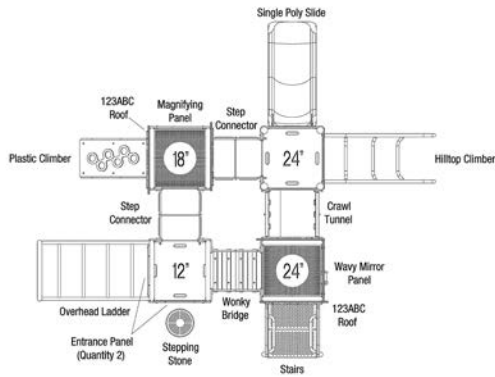

### PLAYTOTS #3

Age:	2 to 5 (1.5 to 5 CAN)	ASTM F1487:	✓
Play Events:	16	CAN/CSA-Z614:	✓
Use Zone:	29' x 27' (8.8 x 8.2m)	CPSC Pub.325:	✓

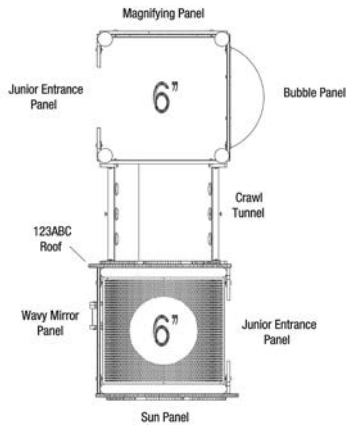

### PLAYTOTS #4

Age:	2 to 5 (1.5 to 5 CAN)	ASTM F1487:	✓
Play Events:	8	CAN/CSA-Z614:	✓
Use Zone:	20' x 16' (6.1 x 4.9m)	CPSC Pub.325:	✓



# Motion Toys

Rocking and swinging are important for children's physical and mental development. Perhaps more importantly, though, is the fact that it is so fun to do.

Henderson Recreation has a variety of both single and multi-user spring riders, in a wide array of themes and designs; all of which are certain to get your children rocking!











### Lucky Clover

Model No. MT209  
 Best User Age- 1.5 to 12  
 Use Zone- 15'-7" (4.7m) diameter  
 Perfect for small spaces. Designed for up to four users.



### Shark Motion Toy

Model No. MT213  
 Best User Age- 1.5 to 12  
 Use Zone- 13'-6" x 15'-6" (4.1m x 4.7m)  
 Designed for one user.

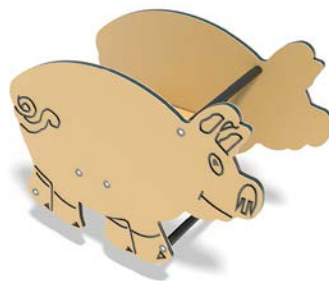

### Pig Motion Toy

Model No. MT220  
 Best User Age- 1.5 to 12  
 Use Zone- 13'-6" x 15'-6" (4.1m x 4.7m)  
 Designed for one user.



### Triceratops Motion Toy

Model No. MT233  
 Best User Age- 1.5 to 12  
 Use Zone- 13'-6" x 15'-0" (4.1m x 4.6m)  
 Designed for one user.



### Dino Motion Toy

Model No. MT013  
 Best User Age- 1.5 to 12  
 Use Zone- 13'-6" x 15'-0" (4.1m x 4.6m)  
 Designed for one user.



### Mr. Crabby

Model No. MT218  
 Best User Age- 1.5 to 12  
 Use Zone- 13'-6" x 15'-6" (4.1m x 4.7m)  
 Designed for one user.



### Sheep Motion Toy

Model No. MT022  
Best User Age- 1.5 to 12  
Use Zone- 13'-6" x 15'-6" (4.1m x 4.7m)  
Designed for one user.



### Tractor Motion Toy

Model No. MT024  
Best User Age- 1.5 to 12  
Use Zone- 13'-6" x 15'-6" (4.1m x 4.7m)  
Designed for one user.



### Wally the Whale

Model No. MT018  
Best User Age- 1.5 to 12  
Use Zone- 13'-6" x 15'-0" (4.1m x 4.6m) Available in all roto-molded colors. Designed for one user.



### Cow Motion Toy

Model No. MT023  
Best User Age- 1.5 to 12  
Use Zone- 13'-6" x 15'-6" (4.1m x 4.7m)  
Designed for one user.



### Racecar Motion Toy

Model No. MT234  
Best User Age- 1.5 to 12  
Use Zone- 13'-6" x 15'-6" (4.1m x 4.7m)  
Designed for one user.



### Jet Motion Toy

Model No. MT217  
Best User Age- 1.5 to 12  
Use Zone- 13'-6" x 15'-6" (4.1m x 4.7m)  
Designed for one user.





### Train Motion Toy

Model No. MT226  
 Best User Age- 1.5 to 12  
 Use Zone- 13'-6" x 14'-6" (4.1m x 4.4m)  
 Designed for one user.



### Bulldozer Motion Toy

Model No. MT228  
 Best User Age- 1.5 to 12  
 Use Zone- 13'-6" x 15' (4.1m x 4.6m)  
 Designed for one user.



### Fire Truck

Model No. MT221  
 Best User Age- 1.5 to 12  
 Use Zone- 14' x 15' (4.3m x 4.6m)  
 Designed for one user.



### Skateboard Rider

Model No. MT236  
 Best User Age- 1.5 to 12  
 Use Zone- 17' x 15' (5.2m x 4.6m)  
 Designed for one user.



### Canoe Motion Toy

Model No. MT239  
 Best User Age- 1.5 to 12  
 Use Zone- 13'-6" x 15'-6" (4.1m x 4.7m)  
 Designed for one user.



### Racing Motorcycle

Model No. MT240  
 Best User Age- 1.5 to 12  
 Use Zone- 13'-6" x 15'-6" (4.1m x 4.7m)  
 Designed for one user.



### ABC Motion Toy

Model No. MT241  
 Best User Age- 1.5 to 12  
 Use Zone- 13'-6" x 15'-6" (4.1m x 4.7m)  
 Designed for one user.



### Motorcycle Motion Toy

Model No. MT235  
 Best User Age- 1.5 to 12  
 Use Zone- 13'-6" x 15' (4.1m x 4.6m)  
 Designed for one user.



### Car Motion Toy

Model No. MT006  
Best User Age- 1.5 to 12  
Use Zone- 13'-6" x 15'-6" (4.1m x 4.7m)  
Designed for one user.

---



### SUV Motion Toy

Model No. MT216  
Best User Age- 1.5 to 12  
Use Zone- 13'-6" x 15'-6" (4.1m x 4.7m)  
Designed for one user.

---



### Octopus Motion Toy

Model No. MT212  
Best User Age- 1.5 to 12  
Use Zone- 15'-7" (4.7m) diameter  
Designed for up to four users.

---



### Rock-A-Round

Model No. MT222  
Best User Age- 1.5 to 12  
Use Zone- 18' (5.5m) diameter  
A popular wobbling platform for multiple users.

---



### Retro Rocker

Model No. MT223  
Best User Age- 5 to 12  
Use Zone- 17' x 13'-6" (5.2m x 4.1m)  
Designed for two users.

---





**Mr. Fishy Multi See-Saw:  
Accessible**

Model No. MT210 (Accessible)  
Best User Age- 1.5 to 12  
Use Zone- 15'-6" x 22'-6" (4.7m x 6.9m)  
Designed for four or more users.

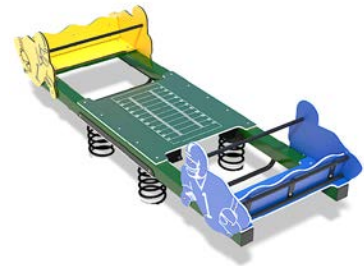

**Ruckus Football Multi See-Saw**

Model No. MT237  
Best User Age- 1.5 to 12  
Use Zone- 22'-6" x 15'-6" (6.9m x 4.7m)  
Designed for four or more users.

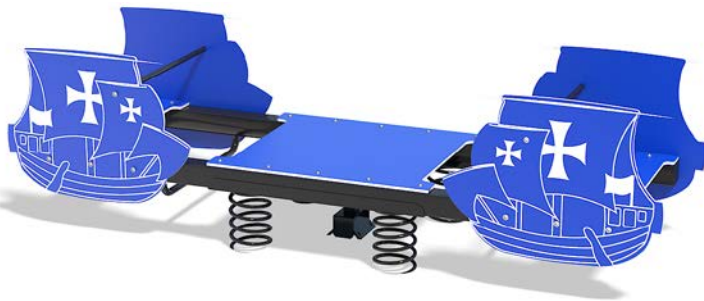

**Pirate Ship Multi See-Saw**

Model No. MT219  
Best User Age- 1.5 to 12  
Use Zone- 22'-6" x 15'-6" (6.9m x 4.7m)  
Designed for four or more users.

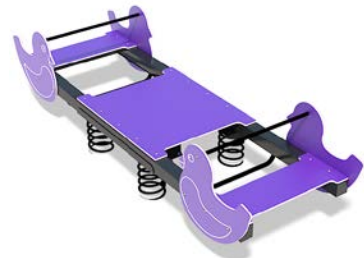

**Bird Multi See-Saw**

Model No. MT206  
Best User Age- 1.5 to 12  
Use Zone- 22'-6" x 15'-6" (6.9m x 4.7m)  
Designed for four or more users.

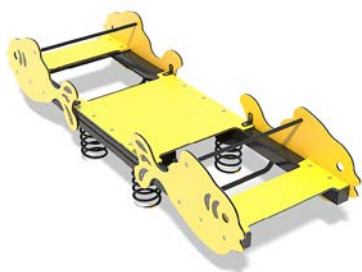

**Mr. Fishy Multi See-Saw**

Model No. MT211  
Best User Age- 1.5 to 12  
Use Zone- 15'-6" x 22'-6" (4.7m x 6.9m)  
Designed for four or more users.



**Seal Quad See-Saw**

Model No. MT207  
Best User Age- 1.5 to 12  
Use Zone- 22'-6" x 22'-6" (6.9m x 6.9m)  
Designed for up to four users.



NEW

### Four Seater Spring See-Saw

Model No. MT238  
 Best User Age- 1.5 to 12  
 Use Zone- 25' x 15' (7.6m x 4.6m)  
 Includes two oversized springs. Designed for four users.



### Schmoo See-Saw

Model No. MT208  
 Best User Age- 1.5 to 12  
 Use Zone- 22' x 14'-6" (6.7m x 4.4m)  
 Includes two oversized springs. Designed for two users.



### Dino See-Saw

Model No. MT214  
 Best User Age- 1.5 to 12  
 Use Zone- 22' x 14'-6" (6.7m x 4.4m)  
 Includes two oversized springs. Designed for two users.



### Traditional Teeter Totter

Model No. MT224  
 Best User Age- 5 to 12  
 Use Zone- 23' x 14' (7m x 4.3m)  
 All steel construction. Designed for two users.



### Dino Quad See-Saw

Model No. MT215  
 Best User Age- 1.5 to 12  
 Use Zone- 22'-6" x 22'-6" (6.9m x 6.9m)  
 Designed for up to four users.





Feel the Fun!





## Freestanding Play

Looking for the perfect way to complete your playground? Henderson offers loads of innovative freestanding play events and stand-alone play items. Children can't get enough of these popular, self-contained play solutions.

Choose from new and exciting spinners, climbers, sandboxes, playhouses, and much more. As a compact total play solution or an addition to a larger play environment, our selection is a winning combination of fun and durability.





## Spider Net

Model No. CB320  
 Best User Age- 5 to 12  
 Use Zone- 22' x 13' (6.8m x 4.0m)  
 A fun and flexible cable climbing web.



## Twist Climber

Model No. TE021  
 Use Zone- 17' x 15' (5.2m x 4.6m)  
 Best User Age- 5 to 12  
 Three ladder-type climbers in one.

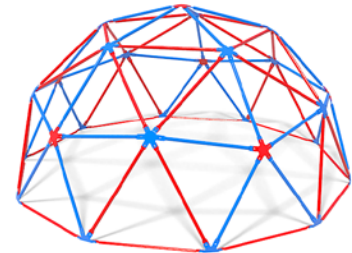

## Dome Climber

Model No. TE038  
 Best User Age- 5 to 12  
 Use Zone- 22' x 22' (6.7m x 6.7)  
 A modern take on the traditional dome climber.



## Triple Cliff Hanger

Model No. TE029- Aligned Layout  
 Best User Age- 5 to 12  
 Use Zone- 17'-2" x 25'-5" (5.2m x 7.7m)  
 Our most popular layout of Cliff Hangers. Kids love to traverse this challenging climber.



## Cliff Hanger

Model No. TE060  
 Best User Age- 5 to 12  
 Use Zone- 16' x 17'-10" (4.9m x 5.4m)  
 A great freestanding climber on it's own or used in a functionally linked playground layout.



### Circle Cliff Hanger

Model No. TE029-Circle Layout  
 Best User Age- 5 to 12  
 Use Zone- 21'-2" dia. (6.5m dia.)  
 This layout of three cliff hangers looks link a rocket.

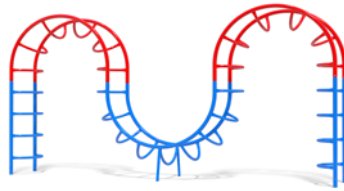

### Camelback Climber

Model No. TE039  
 Best User Age- 5 to 12  
 Use Zone- 27' x 15' (8.2m x 4.6m)  
 Extra-large play activity combines climbing and overhead play elements and accommodates many children.



### Orbiter

Model No. TE031  
 Best User Age- 5 to 12  
 Use Zone- 19' x 19' (5.8m x 5.8m)  
 A spinning overhead activity with room for multiple children.



### Space Station

Model No. TE020  
 Best User Age- 5 to 12  
 Use Zone- 25' x 24' (7.7m x 7.4m)  
 Equipped with two pairs of climbers and one giant, looping overhead track.



### Standing Super Spinner

Model No. TE045  
 Best User Age- 5 to 12  
 Use Zone- 14' (4.3m) diameter  
 A favorite new spinning activity with a modern look. For use in an upright position. Non-skid base for safety.



### Seated Super Spinner

Model No. TE046  
 Best User Age- 5 to 12  
 Use Zone- 14' (4.3m) diameter  
 A popular new spinning activity with a modern design. For use while seated. Non-skid base for safety.



### Sand Digger

Model No. TE010  
 Best User Age- 1.5 to 12  
 A fully-functional digger. Complete with molded seat, moving arms and bucket. Rotates 360 degrees. Accessible version also available.



### Accessible Digger

Model No. TE012  
 Best User Age- 1.5 to 12  
 A fully-functional digger with moving arms and bucket. Designed specifically for children in wheelchairs.



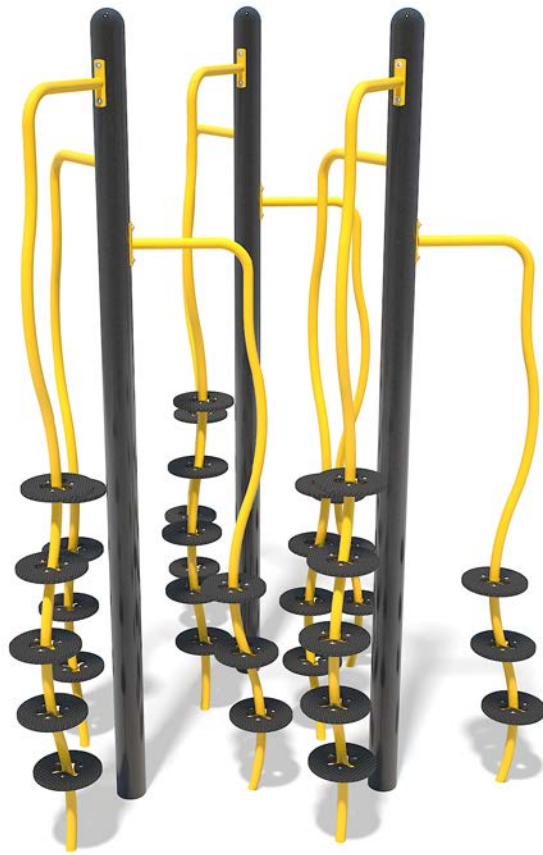

NEW

### Transporter Super Cluster

Model No. TE049  
 Best User Age- 5 to 12  
 Use Zone- 19'-7" x 20' (5.9m x 6.1m)  
 We've turned the popular Transporter climber into a jungle. Multiple ways up and down and all round will make this new climber a ton of fun for kids.



### 4 Way Lava Rock Climber

Model No. TE053  
 Best User Age- 5 to 12  
 Use Zone- 20'-9" x 20'-9" (6.3m x 6.3m)  
 Four ways up and down and the ability to climb around to the other climbers makes this freestanding 4 Way Lava Rock Climber a challenging and fun event for children.



### Double Ridge Rock Climber

Model No. TE051  
 Best User Age- 5 to 12  
 Use Zone- 15'-10" x 20'-9" (4.8m x 6.3m)  
 We put two Ridge Rock Climbers together to create a fantastic freestanding rock climbing event that kids will love.



NEW

### Single Cluster

Model No. TE058  
 Best User Age- 5 to 12  
 Use Zone- 15'-11" x 16'-5" (6.0m x 5.0m)  
 Our popular Transporter climber attached to a post in a cluster of three provides a fun and interesting climb for children.

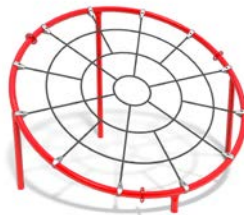

NEW

### Inclined Vortex Net

Model No. TE057  
 Best User Age- 5 to 12  
 Use Zone- 18'-8" x 19'-11" (5.7m x 6.1m)  
 A giant spider web rope climber makes a great place for kids to climb or hang out with friends.



### 3 Way Lava Rock Climber

Model No. TE052  
 Best User Age- 5 to 12  
 Use Zone- 20'-4" x 21'-6" (6.2m x 6.6m)  
 What's better than climbing a Lava Rock Climber? Climbing three of them all connected together. This fun and cool looking rock climber is a kid pleaser.



### Spiral Slide and Ladder

Model No. B301298  
 Best User Age- 5 to 12  
 Use Zone- 18' x 23' (5.5m x 7.0m)  
 Includes 6' (1.8m) spiral slide, deck, barrier rails, ladder and handrails.



### 4ft Freestanding Wave Slide

Model No. B301295  
 Best User Age- 5 to 12  
 Use Zone- 26' x 17' (9.2m x 6.1m)  
 Includes wavy slide, deck, barrier rails, ladder and handrails.



### 6ft Freestanding Wave Slide

Model No. B301297  
 Use Zone- 29' x 17' (8.8m x 5.2m)  
 Best User Age- 5 to 12  
 Includes poly wave slide, deck, barrier rails, ladder and handrails.



### 6ft Stainless Slide & Ladder

Model No. B301301  
 Use Zone- 30' x 20' (9.2m x 6.1m)  
 Best User Age- 5 to 12  
 Includes stainless steel slide with steel sides, deck, barrier rails, ladder and handrails.



### 4ft Stainless Slide & Ladder

Model No. B301299  
 Use Zone- 25' x 19' (7.7m x 5.8m)  
 Best User Age- 5 to 12  
 Includes stainless steel slide with steel sides, deck, barrier rails, ladder and handrails.



### Freestanding Wave Slide & Climber Combo

Model No. TS034  
 Use Zone- 26'-1" x 19'-2" (8.0m x 5.8m)  
 Best User Age- 5 to 12  
 This 6' (1.8m) high deck includes a Wave Slide, Rockwall Climber, and Spacewalk.





### Safari 4 x 4

Model No. TE027  
 Best User Age- 1.5 to 12  
 Let the adventure begin with this bold 4x4. Includes two steering wheels and two bench seats. Steel and HDPE construction.



### City Bus

Model No. TE026  
 Best User Age- 1.5 to 12  
 A big city bus with steering wheel and three bench seats. Steel and HDPE construction.



### Junior Sports Car

Model No. TE054  
 Best User Age- 1.5 to 12  
 This little sport car has it all! Dual gears for an engine, four race car seats, two steering wheels and a manual transmission shifter. Steel frame and HDPE construction.



### School Bus

Model No. TE025  
 Best User Age- 1.5 to 12  
 A play school bus with steering wheel and three bench seats. An early childhood favorite. Steel and HDPE construction.



### Accessible School Bus

Model No. TE042  
 Best User Age- 1.5 to 12  
 Includes two steering wheels and plenty of seating. Steel and HDPE construction.



## Pickup Truck

Model No. TE041

Best User Age- 1.5 to 12

This play truck is ready for adventure. Includes two steering wheels and two bench seats. Steel construction.



## Fire Engine

Model No. TE028

Best User Age- 1.5 to 12

A large play fire engine. Includes steering wheel, three bench seats and vertical rails. Steel and HDPE construction.



## 4 X 4

Model No. TE009

Best User Age- 1.5 to 12

A play vehicle, great for imaginative play. Includes two steering wheels and seating. Steel and HDPE construction.



## Beetle Bug

Model No. TE043

Best User Age- 1.5 to 12

Great for dramatic and imaginary play. Includes two steering wheels and two bench seats. Steel construction.





NEW

## Junior Log Cabin

Model No.

Best User Age- 1.5 to 5

This little log cabin has a lot to offer. Packed with a bear table, windows, activity mirrors, moving panels and so much more kids will definitely enjoy this creative cabin.



NEW

## Junior Turtle Playhouse

Model No. TE056

Best User Age- 1.5 to 5

This turtle shaped playhouse with a bear picnic table, creative tree, moving panels and matching tray is a winner with kids.



### Cantilever Basketball Standard

Model No. BB020  
Complete with 4-1/2' (114mm) O.D. galvanized steel post, frame, steel backboard, basketball hoop, and chain net.



### Steel Backboard

Model No. BP002  
Fan-shaped, white, powder-coated steel backboard. Basketball hoop and net available separately.



### Panda Hoop Game

Model No. GA200  
A fun basketball-type game for younger children. Ball chute returns ball to player. Includes HDPE front with powder-coated steel post and chute.



### Basketball Hoop with Chain Net

Model No. BP013  
Includes orange double-rim basketball hoop with chain net.  
Model No. BP010 - Chain Net Replacement  
Model No. BP007 - Basketball Hoop



### Basketball Hoop with Nylon Net

Model No. BP012  
Includes orange double-rim basketball hoop with nylon net.  
Model No. BP011 - Nylon Net Replacement  
Model No. BP007 - Basketball Hoop



### Tetherball and Rope

Model No. GA402  
Rubber-composite tetherball and 9' (2743mm) rope.



### Tetherball Game

Model No. GA403  
Complete set includes rubber-composite tetherball, 9' (2743mm) rope and galvanized steel post.



### Triple Hoop Game

Model No. GA102  
An exciting twist on basketball, with one hoop and three ball-return chutes. Roto-molded plastic with galvanized steel post.





## Swings

Forever popular! There is just something about swings that children and adults alike never lose interest in them. Be sure to add them to your play environment.



### Single Bay 8ft Arch Swing

SW340 8ft Arch Swing • 2-SS042 slash-proof baby seats.



### 3 Bay 8ft Arch Swing

SW340 8ft Arch • 2-SW341 • 6-SS043 slash-proof belt seats.



### 2 Bay 8ft Arch Swing

SW340 8ft Arch • SW341 • 4-SS043 slash-proof belt seats.



### 2 Bay 8ft Heavy Duty Arch Swing

SW370 8ft Arch • SW371 • 4-SS043 slash-proof belt seats.



### Standard 2 Bay 8ft Swing

SW300 8ft Standard Swing • SW301 • 2-SS043 slash-proof belt seats • 2-SS042 slash-proof baby seats.



### 2 Bay 8ft Single Post Swing

SW360 8ft Single Post Swing • SW361 • 2-SS043 slash-proof belt seats • 2-SS042 slash-proof baby seats.



### Tire Swing

Model No. SW101  
7' (2134mm) height with a 3.5" (89mm) O.D. x 8 gauge (4mm) galvanized steel topbar. Complete with tire swivel bearing and tire swing assembly.





### Heavy Duty Swing

Model No. SW320 - 8' (2438mm) Height  
 Model No. SW330 - 10' (3048mm) Height  
 With a 3.5" (89mm) O.D. x 8 gauge (4mm) galvanized steel topbar. Complete with heavy duty swing bearings, swing chain and slash-proof belt seats.\*



### Extend-A-Bay™

Model No. SW321 - 8' (2438mm) Height  
 Model No. SW331 - 10' (3048mm) Height  
 Complete with heavy duty swing bearings, swing chain and slash-proof belt seats.\*



### Extend-A-Half-Bay™

Model No. SW322 - 8' (2438mm) Height  
 Model No. SW332 - 10' (3048mm) Height  
 Complete with heavy duty swing bearings, swing chain and slash-proof belt seat.\*



### Standard Swing

Model No. SW300 - 8' (2438mm) Height  
 Model No. SW310 - 10' (3048mm) Height  
 With a 2.375" (60mm) O.D. x 10 gauge (3mm) galvanized steel topbar. Complete with standard swing bearings, swing chain and slash-proof belt seats.\*



### Extend-A-Bay™

Model No. SW301 - 8' (2438mm) Height  
 Model No. SW311 - 10' (3048mm) Height  
 Complete with standard swing bearings, swing chain and slash-proof belt seats.\*



### Extend-A-Half-Bay™

Model No. SW302 - 8' (2438mm) Height  
 Model No. SW312 - 10' (3048mm) Height  
 Complete with standard swing bearings, swing chain and slash-proof belt seat.\*



### Arch Swing

Model No. SW340 - 8' (2438mm) Height  
 Model No. SW350 - 10' (3048mm) Height  
 With a 3.5" (89mm) O.D. x 8 gauge (4mm) galvanized steel topbar. Complete with heavy duty swing bearings, swing chain and slash-proof belt seats.\*



### Extend-A-Bay™

Model No. SW341 - 8' (2438mm) Height  
 Model No. SW351 - 10' (3048mm) Height  
 Complete with heavy duty swing bearings, swing chain and slash-proof belt seats.\*



### Extend-A-Half-Bay™

Model No. SW342 - 8' (2438mm) Height  
 Model No. SW352 - 10' (3048mm) Height  
 Complete with heavy duty swing bearings, swing chain and slash-proof belt seat.\*

\*Slash-proof baby seats and anti-wrap swing bearings available. Additional charges may apply.



### Slash-Proof Belt Seat

Model No. SS043  
A 6' x 24" (152mm x 610mm), belt seat made from a 5/16" (8mm) EPDM rubber and polymer blend with a vandal-proof insert and galvanized steel hardware.



### Slash-Proof Baby Seat

Model No. SS042  
Fully-enclosed infant seat. Seat is a 3/8" (10mm) EPDM rubber and polymer blend with a vandal-proof insert and heavy duty rust-proof hardware.



### Swing Bearings

Model No. SB033 - Heavy Duty Swing Bearing  
For use with a 3.5" (89mm) O.D. topbar.  
Model No. SB032 - Standard Swing Bearing  
For use with a 2.375" (60mm) O.D. topbar.



### Anti-Wrap Swing Bearing

Model No. SB035  
For use with a 3.5" (89mm) O.D. topbar. A bolt-free, stainless steel, non-wrapping swing bearing. May be used to replace existing swing bearings without dismantling the swing set.



### Tire Swing Assembly

Model No. TA014  
Includes tire and swing chain, as shown. Tire swivel bearing available separately.



### Tire Swivel Bearing

Model No. SB010  
For use with tire swing assembly. Tire swing assembly available separately.



### Quick Link

Model No. SP500  
5/16" (8mm) quick link.



### Swing Chain

Model No. SP040  
1/4" (6mm) galvanized swing chain. Custom lengths available.





## Behold Vista

Vista furnishings are truly a sight to see.

Each product in the Vista series is crafted with careful attention to detail; pairing innovative design with meticulous engineering, Vista offers unparalleled quality and unceasing beauty.

Using the most innovative materials and the latest in computer-aided design including 3-D printing, Laser-Cut patterns, and CNC machining, Vista products are manufactured with the specific intention of providing lasting, stunning fixtures to any environment.

The benches in the Vista line are inspired by the

natural simplicity and stunning attraction of the grandest of North American scenery. Vista benches borrow their names from some of the most iconic lakes and waterways of North America. Lakes and waterways which have come to symbolize truly inspiring vistas.

All Vista products are made in North America using environmentally responsible resources. As breathtaking as a serene prairie lake and as rugged as the enduring Rocky Mountains, Vista furnishings are a perfect blend of form and function.

With Vista, it's easy to turn any public space into a scene to behold.

# Introducing our Vista Line

Vista is an attractive product line which can complement any environment, from scenic parks and trails, to urban streets and shopping malls. Call us for your free catalog at 1-800-265-5462 or visit us online at [www.vistafurnishings.com](http://www.vistafurnishings.com).



## Sand Blasted

All metal is sand-blasted to remove any impurities, and to etch the surface in order to promote excellent adhesion of the subsequent layers.

## Zinc Primer

The products are then sprayed with a zinc-rich primer, and allowed to partially cure. E-Coat primer available when required.

## Powder Coat Application

Next, a TGIC-free polyester top coat is administered over the zinc primer.

## Curing Powder Coat

The final stage occurs in a state-of-the-art infrared oven, where all of the combined coatings are cured and altogether hardened into a positively incredible finish.



## Shipping

Finally, each product is carefully packaged using heavy duty shrink wrap, and then physically bolted down for stability during transport.

The end result is something that looks gorgeous no matter where it rests, and maintains its strength and appeal no matter how long it stays there.



## Benches

Vista Furnishings offers you nine different bench design series to choose from. Plus traditional, sport specific, and custom benches as well. We even carry buddy and friendship benches with custom laser cut-outs.



## Waste Receptacles

Vista provides a large variety of waste receptacles to choose from to meet all your needs. You can match them with other Vista Furnishings bench series and products.

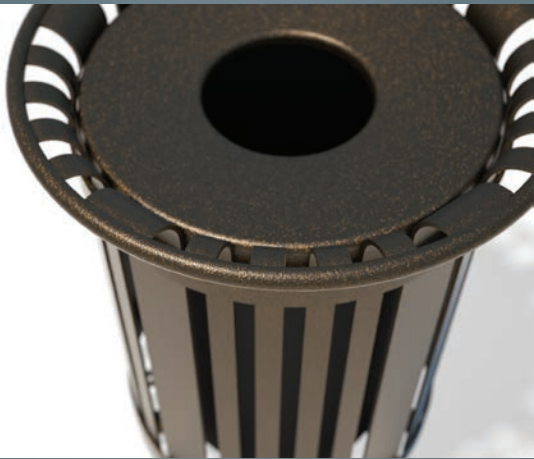

## Tables

Laser cut, Ipe hardwood, cedar, and steel slats table tops are just some of the table versions we carry. Check out our full selection online at [www.vistafurnishings.com](http://www.vistafurnishings.com)



## Bike Racks

Too many bikes crowding your public space? No place for people or kids to park their bikes? Vista Furnishings has the solution. Tons of varieties to choose from. We have designs to park one bike or 22 or link them together to park as many bikes as you need.



# Site Furnishings You Need

Vista has it all. With Vista we can furnish you with planters, benches, tables, recycling solutions, and bike racks. If you need something custom we can do that too! It's easy to turn your space into a scene to behold.



## Waste Receptacles

Check out our beautifully designed and very functional waste receptacles like this 34G (128.70 L) Moraine Square Litter Receptacle with Ipe hardwood horizontal slats.

---



## Bike Racks

Our Vista line has many traditional and creative bike rack designs to solve your bike parking needs. If you need something different we can customize it for you like this customized designed bike rack with laser engraved sign.

---



## Tables

Vista has many well designed and functional tables available in many shapes and sizes. Tabletop materials can be laser cut steel, steel slats, traditional Southern Yellow pine, or Ipe hardwood with complementary bench options. So many versions makes it hard to choose.

---



## Planters

Combine a planter with a park bench to add some beautiful greenery or flowers to a seating area or just place them by themselves. Lots of styles to choose from to match other Vista design lines.

---



## Backless Benches

Almost every design line of Vista Furnishings benches comes with a backless bench design. Beautiful and cost effective alternative to standard benches.

---



## Ash Trays

Control unsightly cigarette butts with a variety of ash tray designs from Vista Furnishings.

---



# Color Combinations

Variety is the spice of life but with more than 60,000 thousand color combinations to choose from picking a color for your playground can become downright overwhelming. To help you choose we have selected fifteen popular color combinations that look great. You can still pick the colors you want to customize the playground to your favorite colors, just check out the color picker on the inside back cover page.



## Option #1

Upright Post: Lime  
 Metal Rails: Burgundy  
 Roto Plastic: Orange  
 HDPE Plastic: Orange/White/Orange



## Option #2

Upright Post: Brown  
 Metal Rails: Green  
 Roto Plastic: Tan  
 HDPE Plastic: Brown/Tan/Brown



## Option #3

Upright Post: Burgundy  
 Metal Rails: Tan  
 Roto Plastic: Green  
 HDPE Plastic: Green/White/Green



## Option #4

Upright Post: Light Blue  
 Metal Rails: Orange  
 Roto Plastic: Geko  
 HDPE Plastic: Orange/White/Orange



## Option #5

Upright Post: Iron Climber  
 Metal Rails: Lime  
 Roto Plastic: Cobalt  
 HDPE Plastic: Blue/White/Blue



## Option #6

Upright Post: Green  
 Metal Rails: Tan  
 Roto Plastic: Burgundy  
 HDPE Plastic: Brown/Tan/Brown



**Option #7**

Upright Post: Blue  
 Metal Rails: Yellow  
 Roto Plastic: Red  
 HDPE Plastic: Blue/White/Blue



**Option #8**

Upright Post: Lime  
 Metal Rails: Orange  
 Roto Plastic: Purple  
 HDPE Plastic: Purple/White/Purple



**Option #9**

Upright Post: Light Blue  
 Metal Rails: Lime  
 Roto Plastic: Violet  
 HDPE Plastic: White/Black/White



**Option #10**

Upright Post: Iron Glimmer  
 Metal Rails: Lime  
 Roto Plastic: Cobalt  
 HDPE Plastic: White/Black/White



**Option #11**

Upright Post: Red  
 Metal Rails: Lime  
 Roto Plastic: Blue  
 HDPE Plastic: Blue/White/Blue



**Option #12**

Upright Post: Purple  
 Metal Rails: Blue  
 Roto Plastic: Teal  
 HDPE Plastic: Purple/White/Purple



**Option #13**

Upright Post: Iron Glimmer  
 Metal Rails: Burgundy  
 Roto Plastic: Pumpkin Spice  
 HDPE Plastic: Green/White/Green



**Option #14**

Upright Post: Purple  
 Metal Rails: Yellow  
 Roto Plastic: Light Green  
 HDPE Plastic: Purple/White/Purple



**Option #15**

Upright Post: Orange  
 Metal Rails: Lime  
 Roto Plastic: Yellow  
 HDPE Plastic: Orange/White/Orange



## Warranty

To the extent permitted by law, these warranties are expressly in lieu of any other implied or expressed warranties or representations by any person, including an implied warranty of merchantability or fitness. Warranties do not cover damage caused by vandalism or abuse.

Warranty claims must be filed within the applicable warranty period and accompanied by a copy of the original invoice or Henderson invoice number. These warranties do not cover cost of freight and/or installation. These warranties do not cover normal wear and tear, surface corrosion on metal parts, discolored surfaces or cosmetic issues. These warranties are valid only if products are installed and maintained according to Henderson's installation instructions.

**Lifetime\*** limited warranty on steel support posts against structural failure due to deterioration caused by defects in materials or manufacturing.

**Lifetime\*** limited warranty on Bolt-N-Go direct-bolt fastening systems against structural failure due to corrosion or deterioration caused by defects in materials or manufacturing.

**20 Year\*** limited warranty on aluminum post caps and Orbis aluminum clamps against structural failure or defects in material or workmanship.

**20 Year\*** limited warranty on Mighty Shades™ steel framework against structural failure due to corrosion or deterioration caused by defects in materials or manufacturing.

**15 Year\*** limited warranty on steel rails, loops and rungs against structural failure due to corrosion or deterioration caused by defects in materials or manufacturing.

**10 Year\*** limited warranty on polyethylene components, sheet plastic, and decks against structural failure due to corrosion or deterioration caused by defects in materials or manufacturing.

**10 Year\*** limited warranty on Southern Yellow Pine pressure-treated wood products against structural failure due to insect infestation and fungal decay caused by defects in materials or manufacturing.

**10 Year\*** limited warranty on Mighty Shades™ fabric against deterioration, rot and seam failure.

**10 Year\*** limited warranty on all Exploration Playgrounds dinosaur digs, dinosaur climbers and other concrete or fibre-reinforced epoxy products against structural failure due to corrosion or deterioration caused by defects in materials or manufacturing.

**5 Year\*** limited warranty on Berliner Rope Play steel-core ropes and rubber components against structural failure or defects in material or workmanship.

### One Year\* General Warranty

Henderson Recreation Equipment Limited warrants that all products not listed above will be free from defects in materials or manufacturing for one year. Henderson Recreation will repair or replace all parts of the product or equipment found to be defective. All warranty periods start at date of invoice.

\*Ask for your copy of our complete warranty.

## Terms of Sale

### Pricing

Prices are F.O.B. factory and do not include freight charges. Prices are subject to change without notice.

### Terms

To Governmental agencies, tax-supported institutions and those with approved credit, payment is due within 30 days of the date of invoice. A 2% per month finance charge will be imposed on all past due accounts. All other orders require a 50% deposit at the time of order entry. The balance will be due by certified cheque upon receipt of shipment (C.O.D.).

### Taxes

If applicable, taxes will be added to the invoice except when a tax exempt certificate is provided with the purchase order at the time of order entry.

### Weights and Sizes

Weights and sizes are reasonably accurate and could vary with product changes. Weights do not include added weight through packaging and shipping.

### Freight Charges

Freight charges are determined and collected by the carrier unless Henderson Recreation Equipment Limited is requested and agrees to prepay and add these costs to the invoice. Freight quotes are valid for thirty days. Due to high energy costs freight surcharges may apply.

### Delays in Transit

Henderson Recreation Equipment Limited is not responsible for delays in transit and such delays will not alter our invoicing terms. If your order does not reach you within a reasonable time after being advised that shipment went forward from our factory, Henderson Recreation Equipment Limited will assist you in the tracing process.

### Loss or Damage in Transit

Henderson Recreation Equipment Limited is not responsible for loss or damage in transit. When we release the material to the carrier, a bill of lading is signed which states that the shipment was received from us complete and in good condition. A copy of this bill of lading is forwarded to you with the shipment and should be checked carefully with the materials you receive.

Any shortage, discrepancy or damage must be noted on the delivery receipt and signed by the driver. Failure to note exceptions on the delivery receipt may impair your right to recovery from the carrier.

### Order Cancellation

Once accepted, orders can be cancelled only with the consent of Henderson Recreation Equipment Limited, and on terms which will indemnify Henderson Recreation Equipment Limited against loss. Cancelled orders will be subject to a 20% restocking fee. Orders for custom-built equipment cannot be cancelled.

### General

Some products in this catalogue may not be exactly as shown. Assembly may be required

for some products.

Henderson Recreation Equipment Limited has a commitment to continuous product development and improvement and therefore reserves the right to improve or alter specifications or discontinue products without notice.

## Standards

### International Play Equipment Manufacturers Association (IPEMA)

Henderson is a member in good standing of IPEMA. IPEMA is a member-driven, international trade organization that represents and promotes an open market for manufacturers of play equipment.

In the interest of playground safety, the International Play Equipment Manufacturers Association (IPEMA) provides a Third Party Certification Service whereby a designated independent laboratory validates a participant's certification of conformance to ASTM F1487, Standard Consumer Safety Performance Specification for Playground Equipment for Public Use, except sections 7.1.1, 10 and 12.6.1; to CAN/CSA-Z614, Children's Playspaces and Equipment, except clauses 9.8, 10 and 11; or both. The use of the corresponding logo in Henderson Recreation Equipment Limited's catalogue signifies that Henderson Recreation Equipment Limited has received written validation from the independent laboratory that the product(s) associated with the use of the logo conforms to the requirements of the indicated standard.

Check the IPEMA website ([www.ipema.org](http://www.ipema.org)) to confirm product validation.

International Play Equipment Manufacturers Association  
4305 North Sixth Street, Suite A  
Harrisburg, PA 17110  
[www.ipema.org](http://www.ipema.org)

### Canadian Standards Association (CSA)

The Canadian Standards Association (CSA) is a not-for-profit membership-based association serving business, industry, government and consumers in Canada and the global marketplace. Henderson designs and manufactures play equipment to be compliant with the release of CAN/CSA-Z614, "Children's Playspaces and Equipment" that is current at the time of manufacture. Henderson is a full member of the Technical Committee that is responsible for the development of the "Children's Playspaces and Equipment" standard.

Canadian Standards Association  
5060 Spectrum Way  
Mississauga, ON L4W 5N6  
[www.csa.ca](http://www.csa.ca)

### The American Society for Testing and Materials (ASTM)

ASTM International is a not-for-profit organization that provides a global forum for the development and publication of

voluntary consensus standards for materials, products, systems and services. ASTM International provides standards that are accepted and used in research and development, product testing, quality systems, and commercial transactions around the world. Henderson designs and manufactures play equipment to be compliant with ASTM F1487, "Standard Consumer Safety Performance Specification for Playground Equipment for Public Use." Henderson is a member of the Technical Subcommittee, F15.29 that is responsible for the development of the "Playground Equipment for Public Use" standard.

ASTM International  
P.O. Box C700, 100 Barr Harbor Drive  
West Conshohocken, PA 19428-2959  
[www.astm.org](http://www.astm.org)

### U.S. Consumer Product Safety Commission (CPSC)

CPSC is an independent federal regulatory agency created to inform the public of current product safety performance information and recommended practices. The CPSC has published document number 325, "Handbook for Public Playground Safety" which presents playground equipment safety information in the form of guidelines. The handbook is a very useful guide for owners and operators of public play environments.

U. S. Consumer Product Safety Commission  
Washington, DC 20207  
[www.cpsc.gov](http://www.cpsc.gov)

### Americans with Disabilities Act (ADA)

Encompassed within the Americans with Disabilities Act (ADA), the Access Board has published Accessibility Guidelines for Play Areas. Your Henderson sales representative can assist you in determining proper accessibility requirements for your play area.

The United States Architectural and Transportation Barriers Compliance Board  
Office of Technical Information Services  
Suite 1000, 1331 F Street, NW  
Washington, DC 20004-1111  
Tel: (202) 272-5434 x 134  
[www.access-board.gov](http://www.access-board.gov)

### ISO 9001:2008 Registered

The ISO 9000 series of standards are developed by the International Organization for Standardization and are recognized worldwide. Companies registered to one or more of these standards have had their quality system certified by an external agency to ensure that their management systems comply with the requirements of the Standard. Henderson Recreation Equipment Ltd. is 9001:2000 Registered.

# Color Options

## Molded Plastic Colors

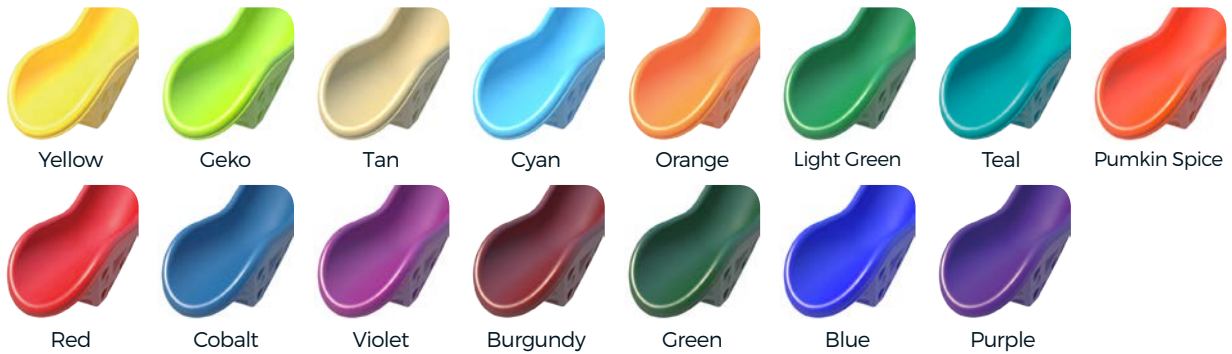

## Post or Upright Colors



## Bi-Color and Solid Sheet Plastic



All colours shown here are approximate. For an exact match, ask your Henderson playground consultant for current colour swatches.





**Henderson**  
Protecting Playground Fun™

© 2017 Henderson Recreation Equipment Limited, P.O. Box 68, 11 Gilbertson Drive, Simcoe, ON Canada N3Y 4K8. Printed in Canada



**IPEMA** INTERNATIONAL  
MEMBER PLAY EQUIPMENT  
MANUFACTURERS  
ASSOCIATION



Distributed by: **ACM Playgrounds, Inc.**  
157 1/2 Seward St., Buchanan, NY 10511  
T. 914-739-6858 - F. 914-736-0554  
[www.acmplaygrounds.com](http://www.acmplaygrounds.com)